

Thank you for purchasing a 8x15 SpaceMaker Storage Shed from Outdoor Living Today. Please take the time to identify all the parts prior to assembly.

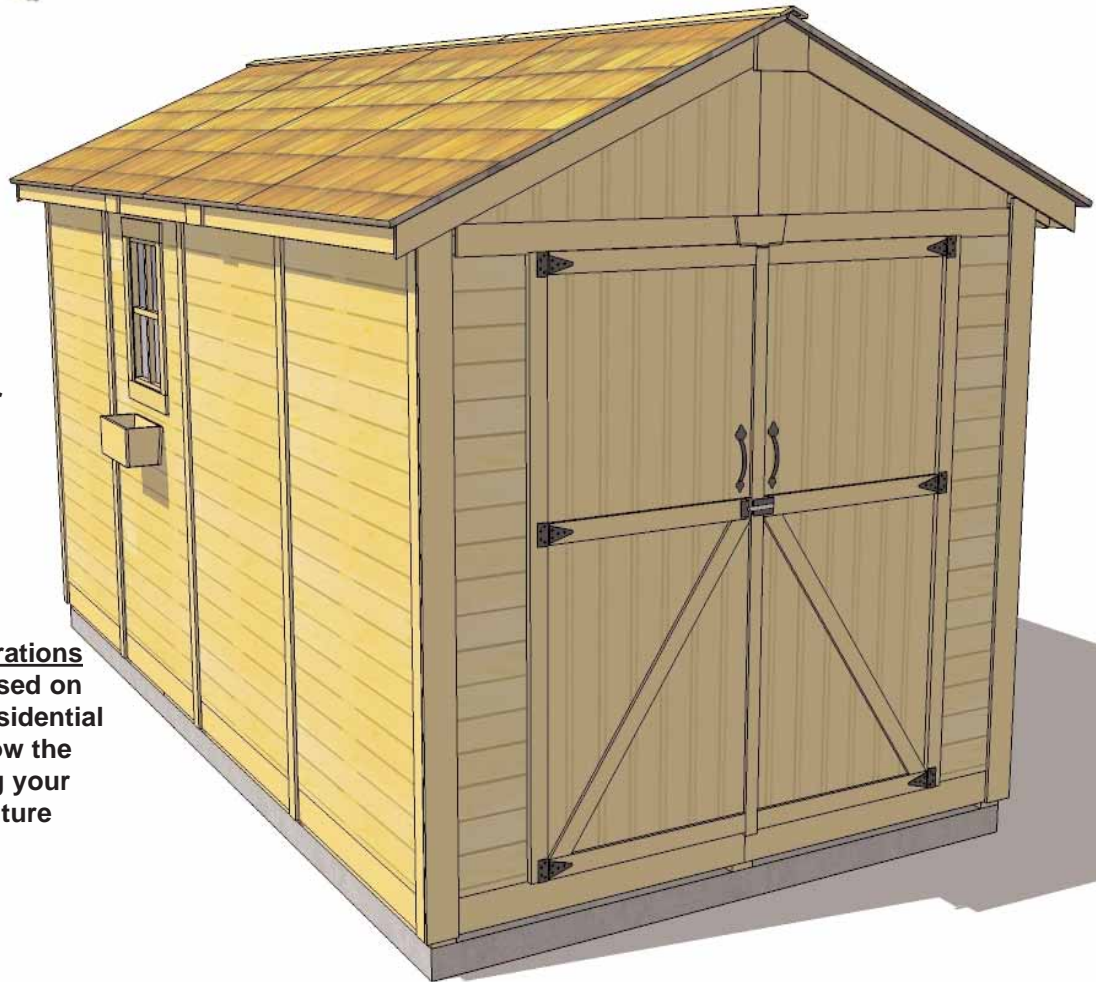

**Safety Points and Other Considerations**

Our products are built for use based on proper installation and normal residential use, on level ground. Please follow the instruction manual when building your shed and retain the manual for future maintenance purposes.

Some of the safety and usage measures you may wish to consider include:

- snow load ratings vary by geographical location. If heavy or wet snowfall occurs, it is advisable to sweep the snow off the roof(s).
- if the product is elevated, any structural and building code requirements are solely the customer's responsibility, and should be abided by.
- in high or gusty wind conditions it is advisable to keep the structure securely grounded.
- have a regular maintenance plan to ensure screws, doors, windows and parts are tight.

Customer agrees to hold Outdoor Living Today Partnership and any Authorized Dealers free of any liability for improper installation, maintenance and repair.

**Important - If you receive a broken or missing part. Please contact our Customer Service Center immediately @ 1-888-658-1658 for assistance.**

In the event of a missing or broken piece, simply call the Outdoor Living Today Customer Support Line @ 1-888-658-1658 within 14 days of your purchase. It is our commitment to you to courier replacement parts, free of charge, within 10 business days of this notification. Replacement parts will not be provided free of charge after the 14 day grace period. Once shipped, all sales are final.

**Thank you for purchasing our 8x15 SpaceMaker Storage Shed.  
Please take the time to identify all the parts prior to assembly.**

## **Parts List:**

### **A. Floor Section**

- 4 - 45 1/2" w x 75" d Floor Joist Frames - Center Joists Unattached
- 8 - 1 1/2" x 3 1/2" x 72" l Center Floor Joists - Unattached
- 4 - 45 1/2" w x 21" d Floor Joist Frames
- 4 - 45 1/2" w x 75" d Plywood Floor - Large
- 4 - 45 1/2" w x 21" d Plywood Floor - Small
  
- 10 - 1 1/2" x 3 1/2" x 68 1/4" Floor Runners
- 5 - 1 1/2" x 3 1/2" x 45 1/2" Floor Runners

### **B. Wall Section**

- 9 - 45 1/2" w x 75" h Wall Panels
- Several Bottom Wall Plates - Unattached to Bottom of Solid Wall Panels
- 1 - 45 1/2" w x 75" h Window Wall Panels
- 2 - 12" w x 73" h Narrow Wall Panel
- 1 - Fixed Window Insert

### **Door Jambs & Header**

- 2 - 1 1/2" t x 3" w x 73" l Vertical Door Jamb
- 1 - 2" t x 3" w x 78" l Door Header
- 2 - 2" t x 3" w x 6 1/2" l Door Header End Plates
- 1 - Left Side Door (with Exterior Vertical Door Stop)
- 1 - Right Side Door
- 2 - 2 1/2" w x 1/2" t x 72" l Interior Vertical Door Stops
- 1 - 2 1/2" w x 1/2" t x 68" l Interior Top Horizontal Door Stop

### **Gable Walls**

- 4 - Gable Halve Walls - Triangular Shaped

### **Top Wall Plates**

- 6 - 3/4" t x 2 1/2" w x 32" l - Front & Rear Top Plates  
(2 pieces Angle cut on end, 1 piece straight cut both ends)
- 4 - 3/4" t x 2 1/2" w x 65 3/4" l Side Top Plate - Angle cut on length
- 2 - 3/4" t x 2 1/2" w x 45 1/2" l Side Top Plate - Angle cut on length

## **C & D. Rafter and Roof Section**

### **Rafter Section**

- 24 - 1 1/2" x 2 2 1/2" x 56 1/2" l - Roof Rafters
- 2 - 3/4" x 3 1/2" x 78" l Roof Ridge Boards
- 2 - 3/4" x 3 1/2" x 70" l Roof Ridge Boards
- 2 - 3/4" x 3 1/2" x 34" Roof Ridge Boards
- 4 - 3/4" x 3 1/2" x 10" l Temporary Roof Ridge Board Connectors
- 4 - 1/2" thick x 4 1/2" wide x 91" l Soffits

### **Roof Section**

- 4 - Outside Rear Roof Panels (Shingles overhanging roof battens on 1 end)
- 4 - Middle Roof Panel (Shingles flush with roof battens)
- 4 - 3/4" t x 3 1/2" w x 72" l Roof Gussets - (angle cut on ends)

## **E. Miscellaneous Section**

### **Ridge Caps**

- 2 - 75 1/4" Roof Ridge Caps
- 1 - 45 1/2" with Steel Plates

### **Bottom Skirting**

- 12 - 1/2" x 4 1/2" x 45 1/2" l Side Bottom Skirting

### **Corner & Sidewall Trim**

- 10 - 1/2" x 2 1/2" w x 79" l Narrow Trim
- 4 - 1/2" x 2 1/2" w x 75" l Filler Trim
- 4 - 1/2" x 4 1/2" w x 82" Wide Trim
- 4 - 1/2" x 3 1/2" w x 44" l Horizontal Gable Trim
- 3 - 1/2" x 2 1/2" x 77 1/2" l Narrow Trim (Front and Rear Wall)

### **Facia Trim**

- 4 - 1/2" x 3 1/2" x 57 1/4" long - Front and Rear Facia  
(Angle cut on ends - 2 right / 2 left)
- 4 - 1/2" x 3 1/2" x 72 3/4" long (Side Facia)
- 2 - 1/2" x 3 1/2" x 45 1/2" long (Side Facia)

### **Filler Shingles (6" wide)**

- 18 pcs 24" long
- 6 pcs 18" long

### **Misc. Pieces**

- 1 - Flower Box
- 2 - Pentagon Facia Plate
- 6 - Facia / Trim Detail Plates
- 1 pc - Spare Wall Siding
- 2 pcs - Spare Shingles- use to shim door, etc

## **Hardware Package**

- 3" Screws
- 2 1/2" Screws -
- 2" Screws -
- 1 1/2" Screws-
- 1 1/4" Screws -
- Finishing Nails -
- 2 - Door Pull Handle
- 1 - Exterior Barrel Bolt - Black
- 1 - Interior Cane Bolt - Black
- 20 - Simpson Strong Tie Rafter Connectors - angled 22 degree
- 8 - Simpson Strong Tie - 90 degree for roof battens
- 6 - Black Tee Hinges for Door with 3/4" screws
- 18 - 1 1/2" long Black Screws for Hinge / Doorway Seam Trim

## **Tools Required:**

- Work Gloves and Safety Glasses
- Screw Gun with square drive and star bits
- Level
- 2 Large Ladders
- Hammer
- Wood Clamps

# A. Floor Section

Exploded view of all parts necessary to complete Floor Section. Identify all parts prior to starting.

Note, Floor Footprint is 182" deep x 96" wide.

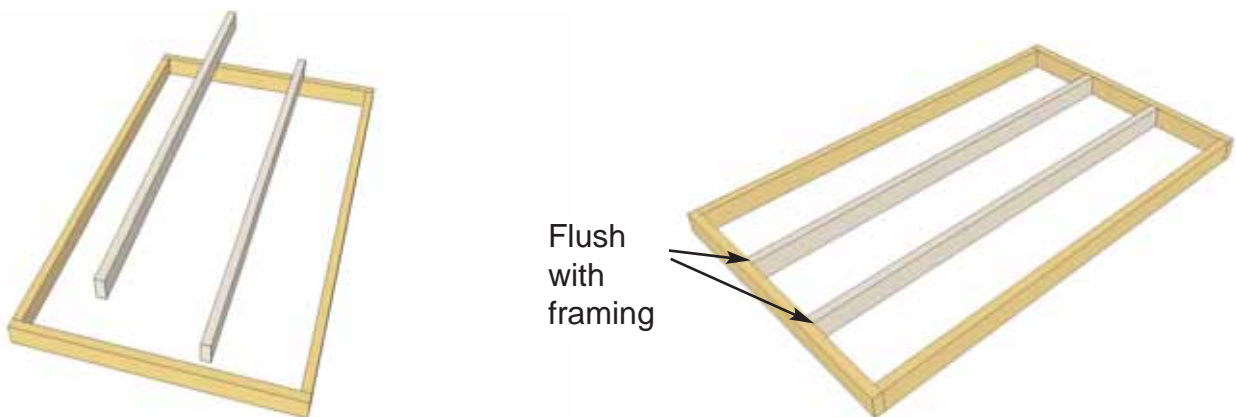
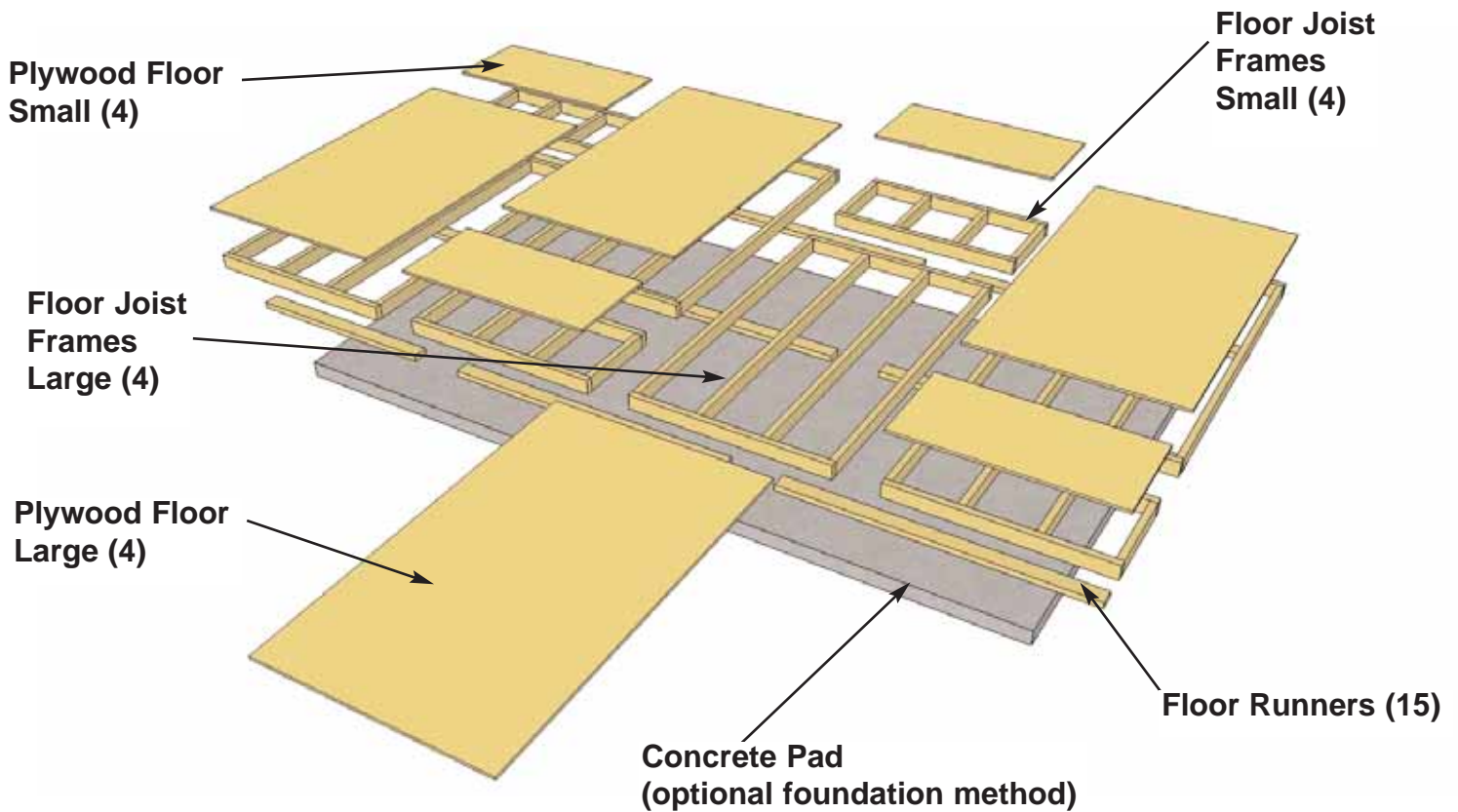

- 1.** Lay out **Large Floor Joist Frame** and **2 Floor Joists** as illustrated above. Position Joists equally in Floor Joist Frame. Use **Small Floor Joist Frame** as a template to determine joist position. Position Joist so flush with framing.

**2.** Lay out **Floor Joist Frames** as illustrated at left. There are 4 larger and 4 smaller Frame Sections. The Footprint for the floor when attached together will be 182" deep x 96" wide.

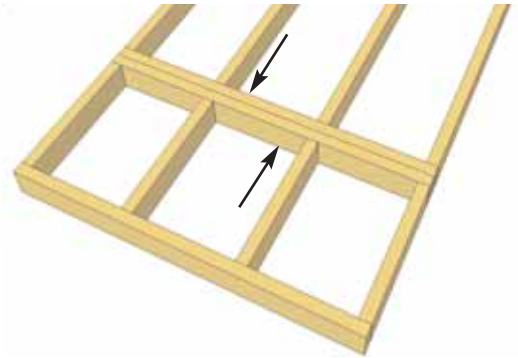
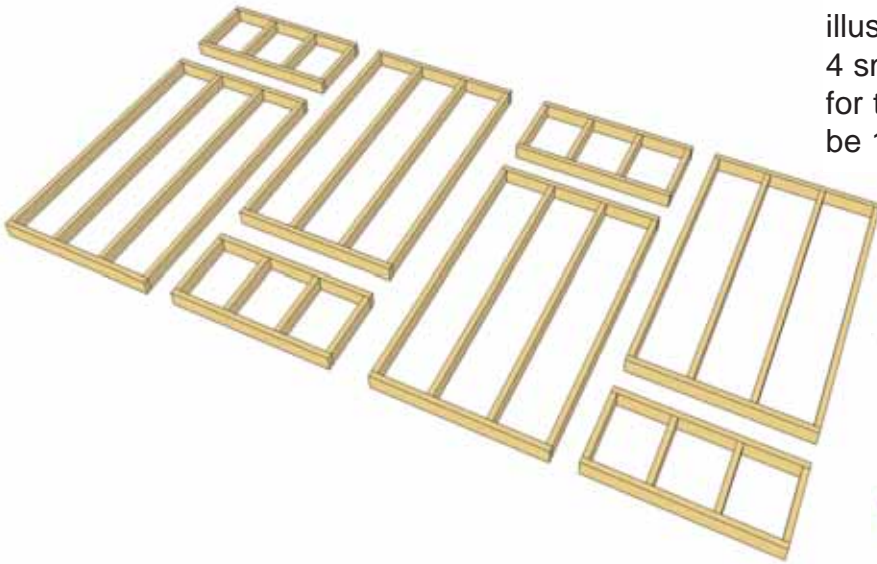

**3.** Attach each large and small floor joist frames together with 6 - 2.5" screws per section.

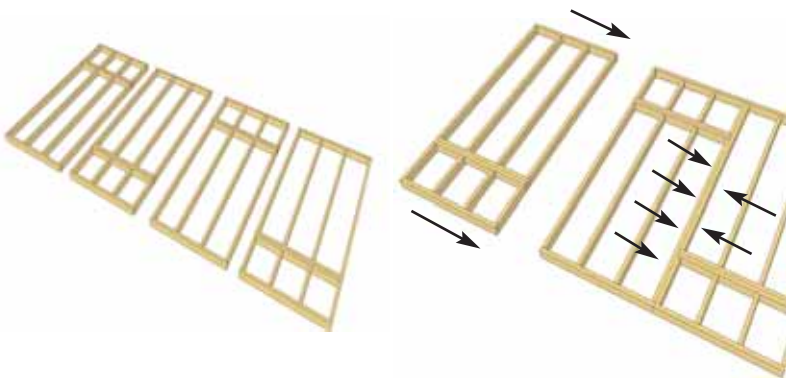

**4.** Complete all large and small frame attachments. Screw each completed section together with 8 - 2.5" screws.

**5.** When completed, your floor footprint should be 182" deep x 96" wide.

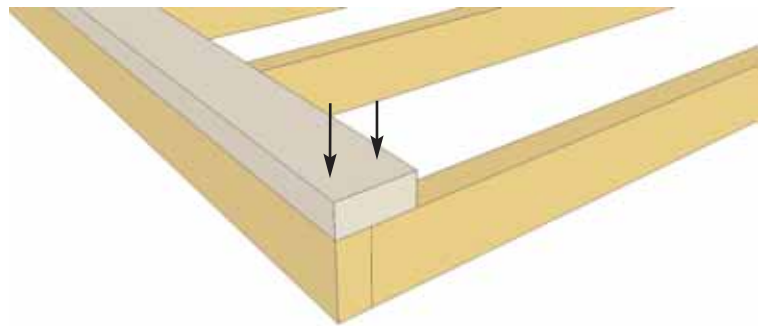

**6.** Attach **Floor Runners** to completed floor frame. There are 3 floor runners per 182" side and 5 completed runners in total. Use 3 - 2.5" screws per Runner. Use 2 - 68.25" and 1 - 45.5" per side.

**7.** Make sure Runners are flush with outside and front and rear floor framing but not overhanging.

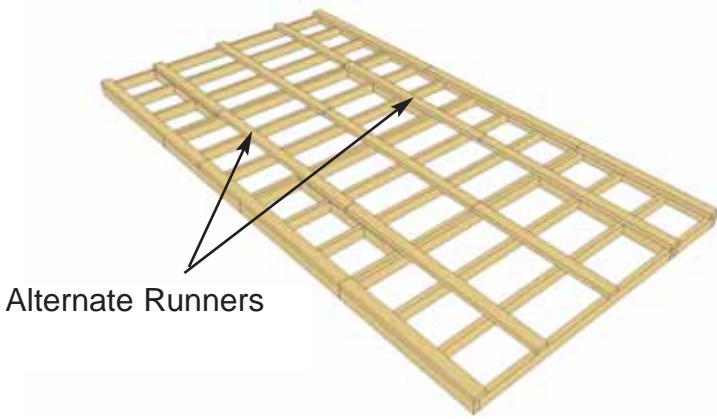

**8.** Complete all Floor Runners.

### Foundations

**Note:** The floor will be flipped over and floor runners will sit on your foundation. It is important to note that having a level foundation is critical. Choosing a foundation will vary between regions. Typical foundations can be concrete pads or patio stones positioned underneath the floor runners.



Concrete Slab Foundation

**9.** With Floor Runners attached, carefully flip the floor over and place on your foundation. **Caution-** you will need 2 people to assist you. Be careful when laying floor down not to bend or twist floor. When in place, level floor completely.

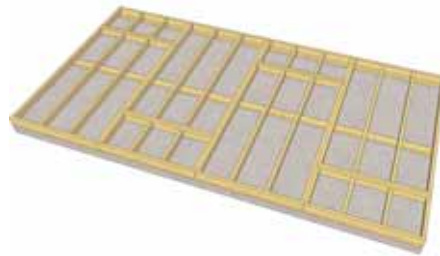

**10.** Position **Plywood Floor** pieces (8) on top of completed floor joists. Plywood will sit flush with outside of floor joist frame.

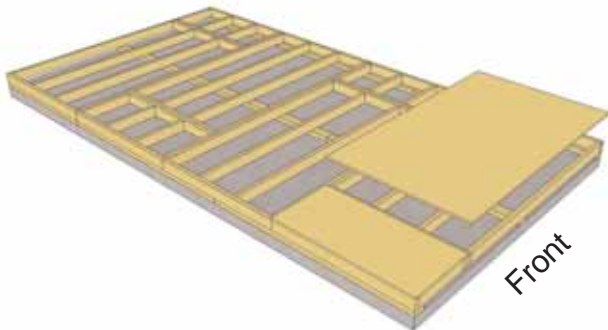

**Hint:** Use a chalk line to mark location of floor joists to determine screw placement.

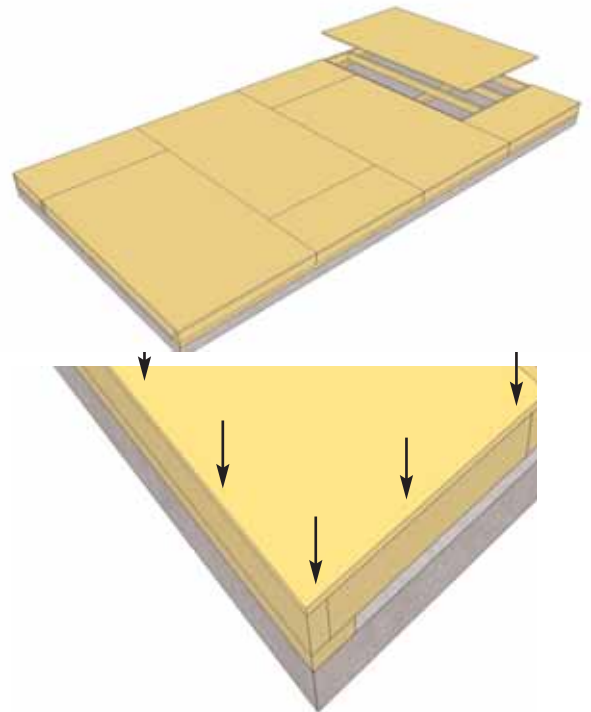
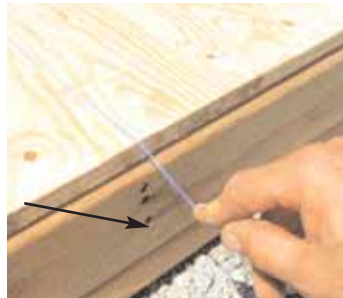

**11.** With Plywood positioned correctly on floor framing, attach with 1 1/4" screws. Use screws every 16".

# B. Wall Section

Exploded view of all parts necessary to complete the Wall Section. Identify all parts prior to starting.

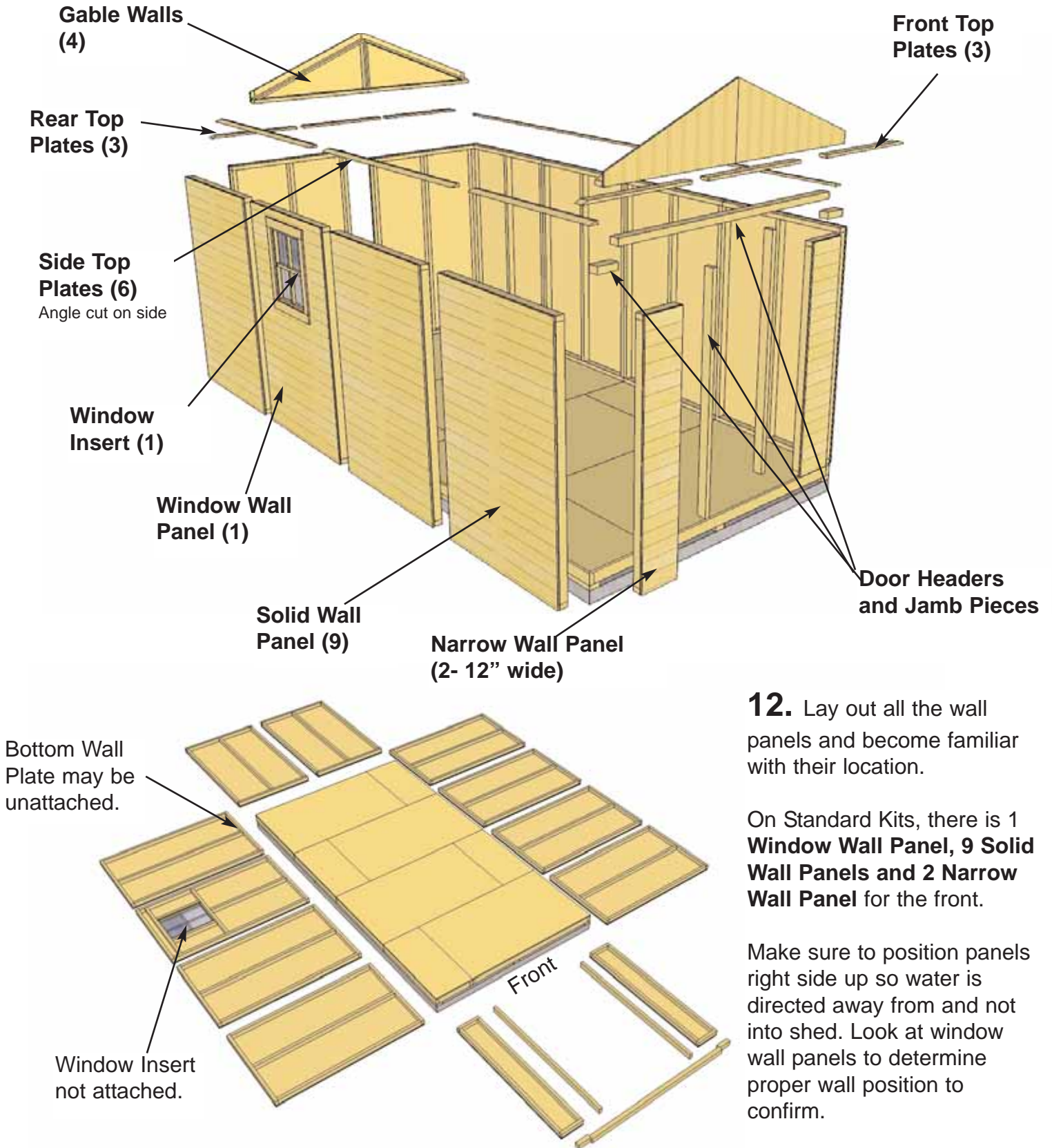

**12.** Lay out all the wall panels and become familiar with their location.

On Standard Kits, there is 1 **Window Wall Panel**, 9 **Solid Wall Panels** and 2 **Narrow Wall Panel** for the front.

Make sure to position panels right side up so water is directed away from and not into shed. Look at window wall panels to determine proper wall position to confirm.

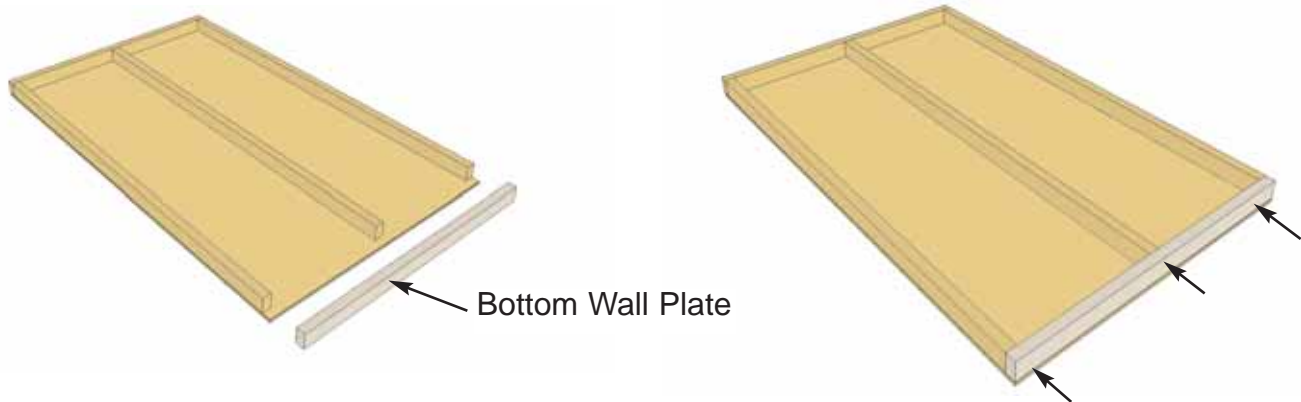

**13.** Starting with **Solid Wall Panels**, carefully lay panel face down. Position and attach **Wall Plate** to bottom of wall studs of each wall panel with 6 - 2 1/2" screws. Position so plates are flush with framing. Note, some Bottom Wall Plates may already be attached to some Solid Walls.

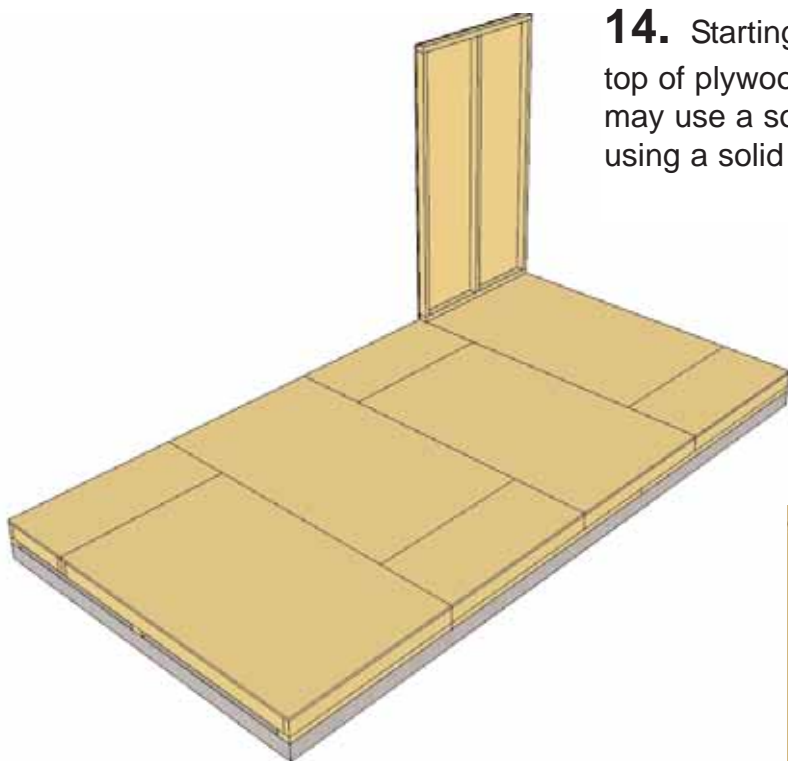

**14.** Starting at Rear Corner, position a Wall Panel on top of plywood floor. Depending on your preference, you may use a solid or window wall panel in this position. If using a solid wall, make sure panel is facing up.

**Important:**

Make sure all walls are aligned in their upright position. If not, water may leak into your shed. Unsure if panel is facing up or down? check siding on window wall panel to match alignment.

**15.** The side wall panels will sit flush at the end of the plywood floor with the front and rear panels sandwiching between them.

**Note:** Siding will overhang the floor by approx. 1/2"

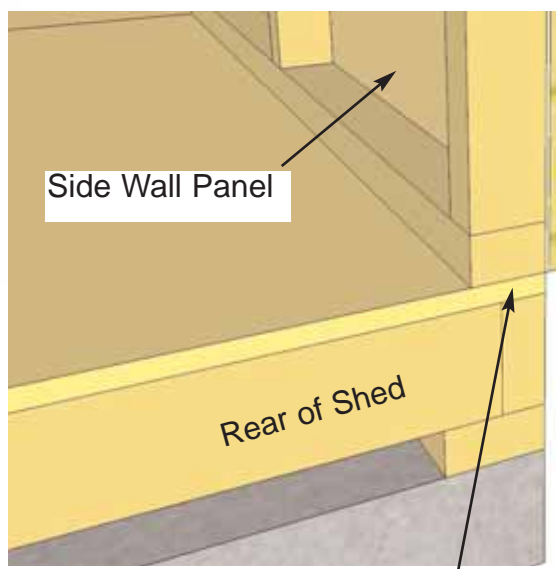

Outside 2x3 Plate of wall panel is flush with outside of plywood when properly aligned.

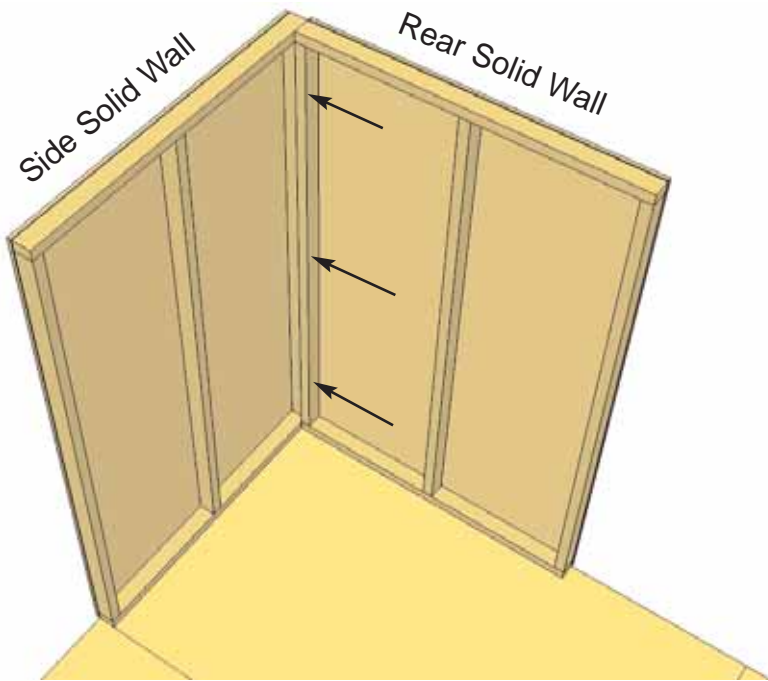

**15.** Position rear solid wall into place on plywood floor. Butt both vertical wall studs of side and rear walls together and attach with 3 - 2.5" screws. Screw at the bottom, middle and top of stud to secure properly.

**Do Not Attach Walls To Floor at this stage.**

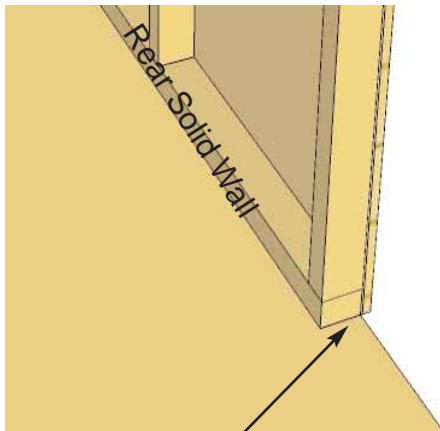

2x3 wall framing flush with outside of plywood.

**16.** With the corner wall attachment complete, position rear wall so bottom 2x3 wall framing is sitting flush with outside floor joists and plywood floor. Wall siding should overhang floor by approximately 1/2"

When positioned correctly, add a second rear wall panel and attach both rear wall panel studs together as per **Step 15**.

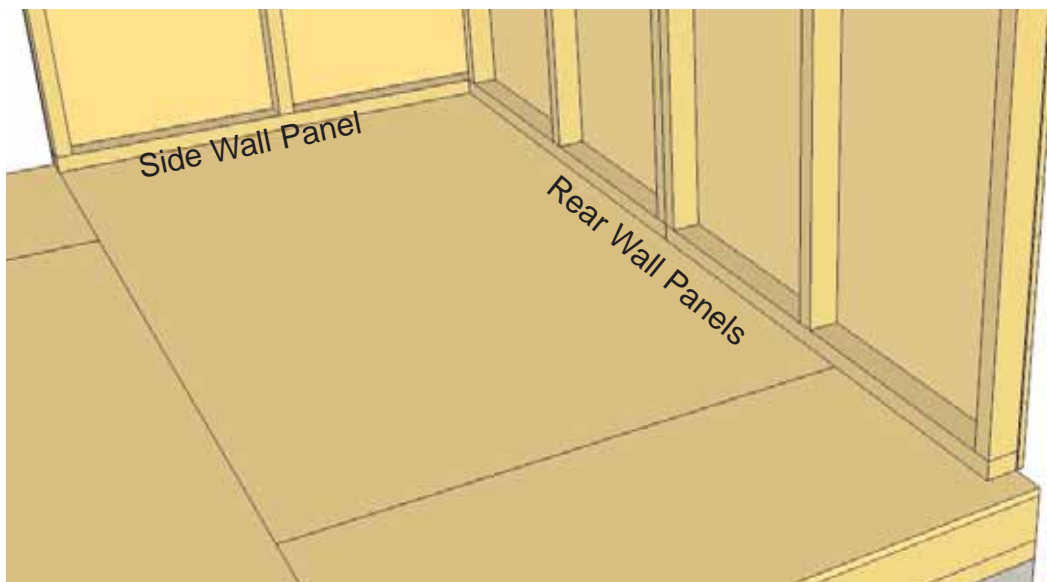
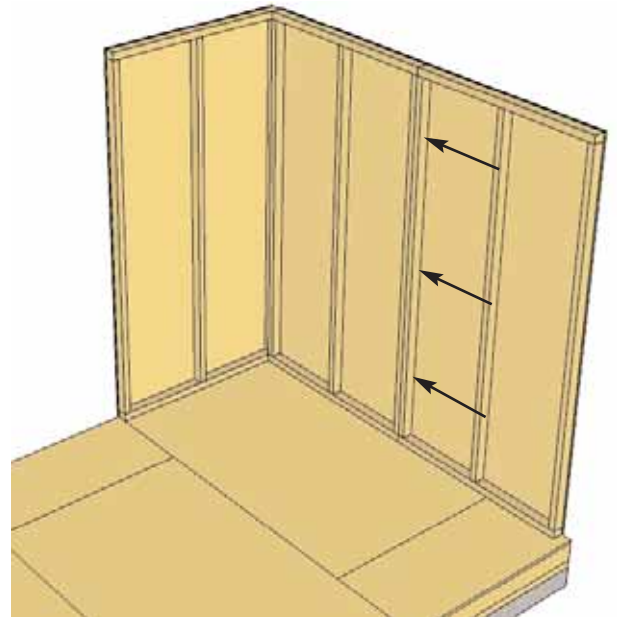

Be sure that rear wall panels fit between the side wall panels (sandwiched)



**17.** Locate **Window Insert**. Place Window Insert into wall opening tight to wall siding. On the inside, shim Window Insert evenly in cavity. Kits include one additional shingle for shimming of the window. When properly positioned, secure Window Insert to wall framing cavity with 4 - 2" screws.

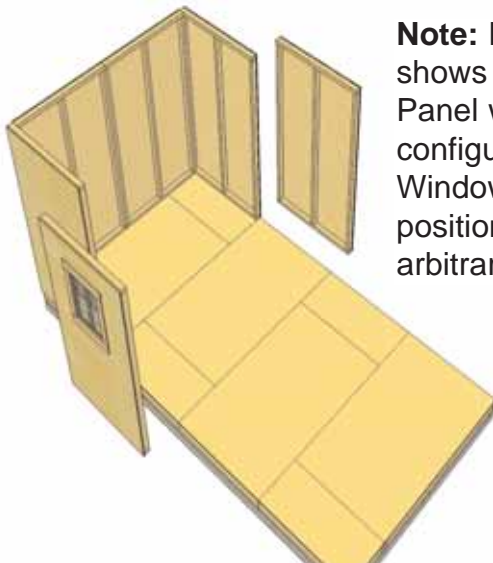

**Note:** Illustration shows Window Panel with side configuration. Window Panel position is arbitrary.

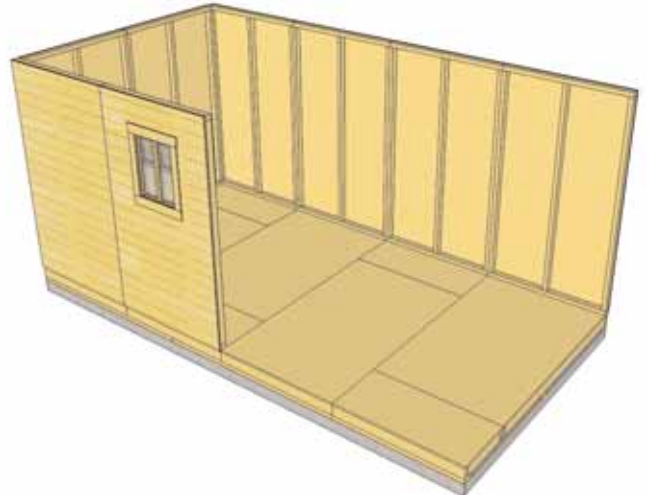

**18.** Start positioning and securing wall panels around your floor. Attach wall studs together as per **Step 15**.

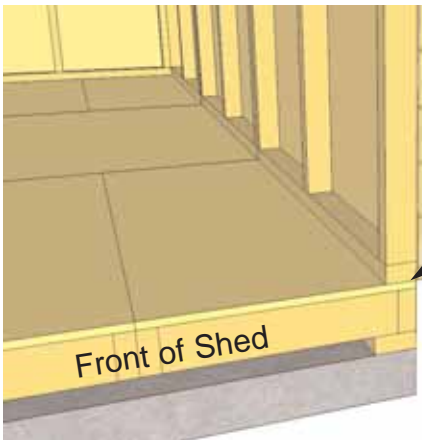

Wall panel will sit flush with plywood at front of shed.

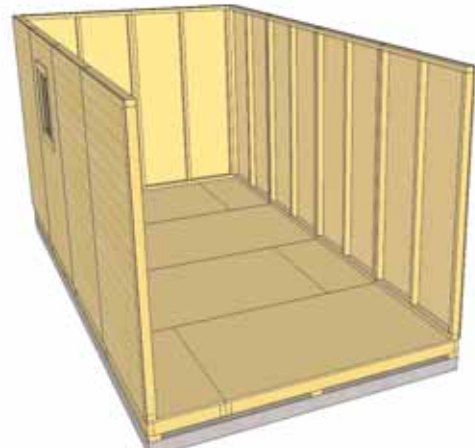

**19.** Complete all wide wall attachments. At the front of the shed, side walls will sit flush with front of floor framing and plywood.

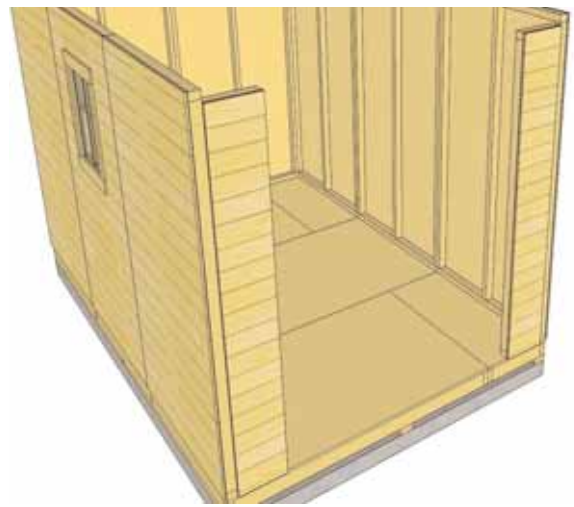
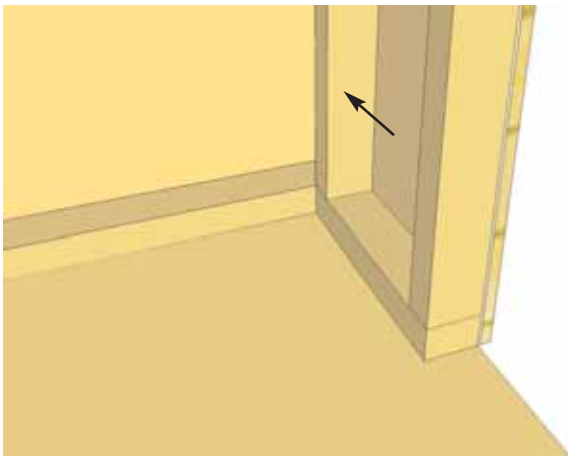

**20.** Complete both Narrow Wall attachments making sure 2x3 wall framing is flush with floor joists and plywood and siding of wall is overhanging the floor by approximately 1/2".

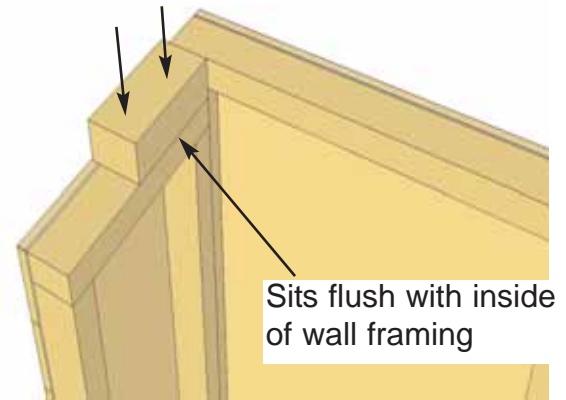
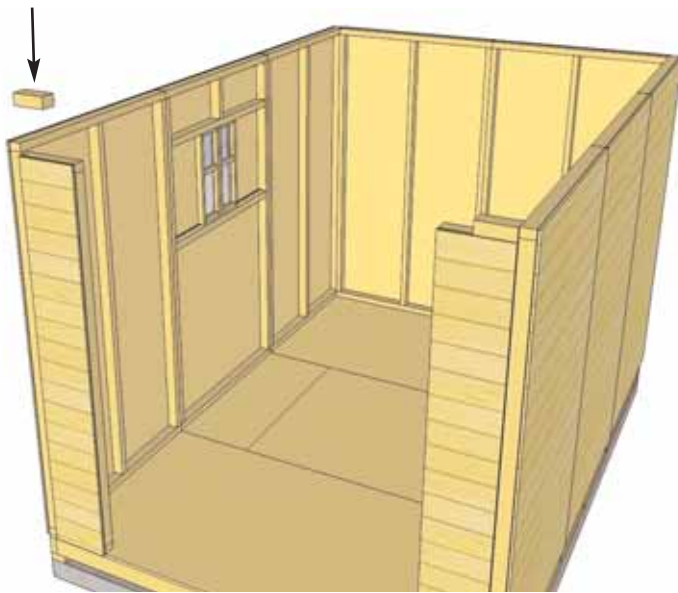

**21.** In the next steps, the Door Header is attached. There are 2 short and 1 long 2" X 3" pieces . Start by attaching both short end pieces using 2 - 2 1/2" screws. Screw from top down into wall framing.

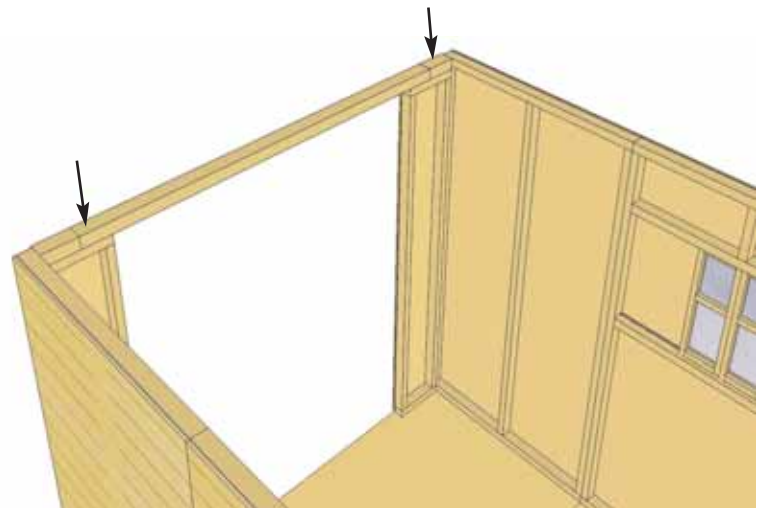
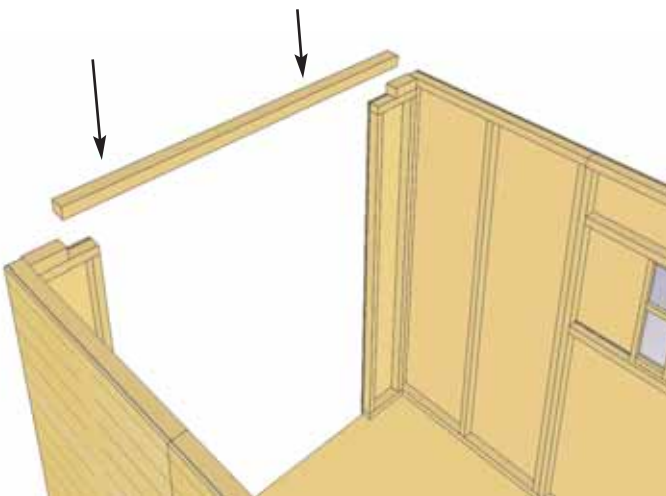

**22.** Position and attach the longer Door Header to wall framing when Header is sitting flush with inside of wall framing and against shorter Door Header end pieces. Attach with 4 - 2 1/2" screws.

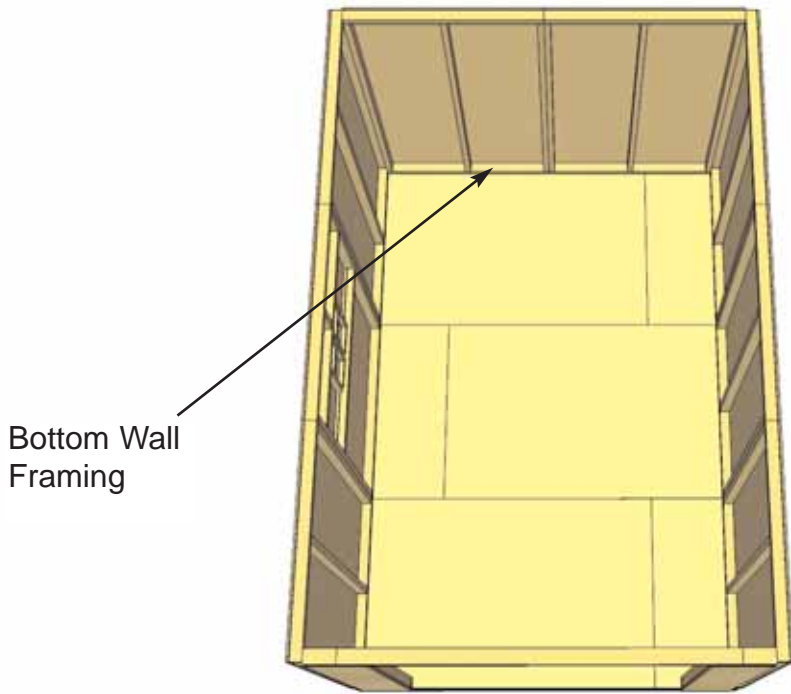

Bottom Wall Framing

**23.** When all walls are attached together, check alignment with the floor. Bottom wall framing should sit flush with outside of floor joists and plywood floor. When positioned correctly, fasten bottom wall plates to floor using 4 - 2 1/2" screws per wall panel.



**24.** Position **Front Top Plates** on top of wall studs so it is flush on the inside with 2x3 wall stud. There are 3 pieces of Front Top Plates ( 2 angle cut /1 end pieces and 1 middle straight cut /both ends). Together, the plates should be centered evenly on the wall left to right.

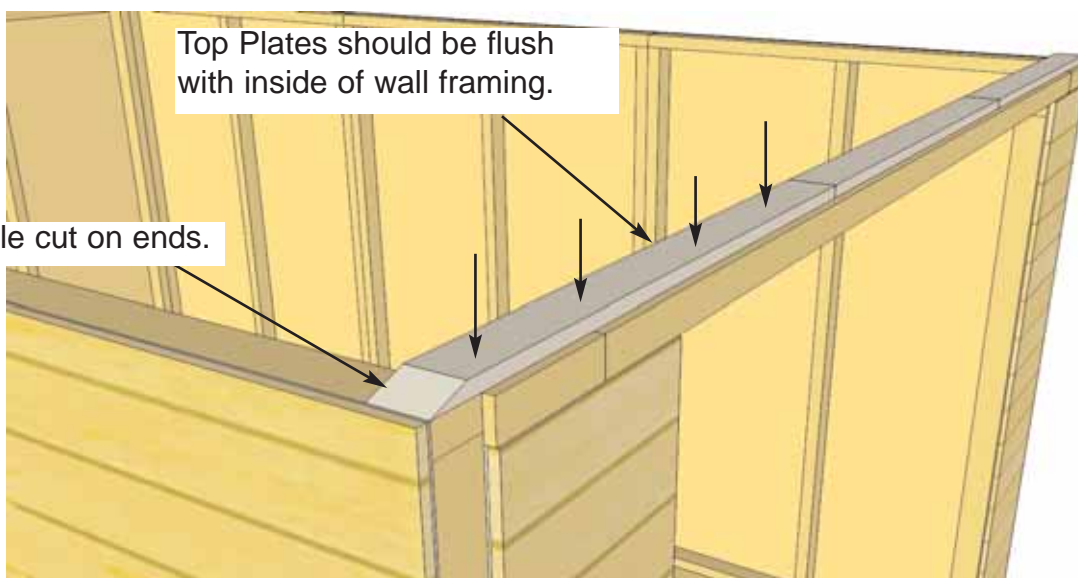
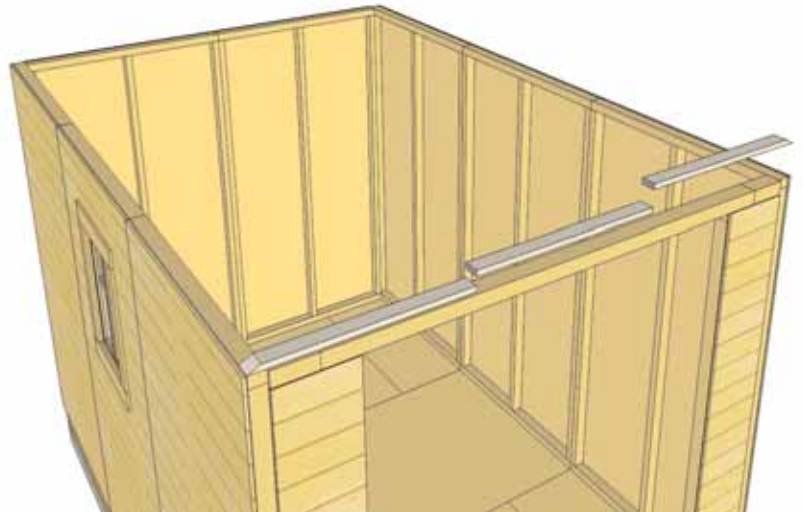

Top Plates should be flush with inside of wall framing.

Angle cut on ends.

**25.** Attach by screwing down into top wall framing with 4 - 2" screws.



**26.** Next, attach the 6 Side Top Plates (3 per side). The side top plates are angle cut down the length. Once again, position top plate on wall plate so it is flush with inside of wall plate. Side plate should also be flush with Front Top Plate. Secure with 4 - 2" screws per piece. Use 47 1/2" long plate for middle.

Rear Top Plates

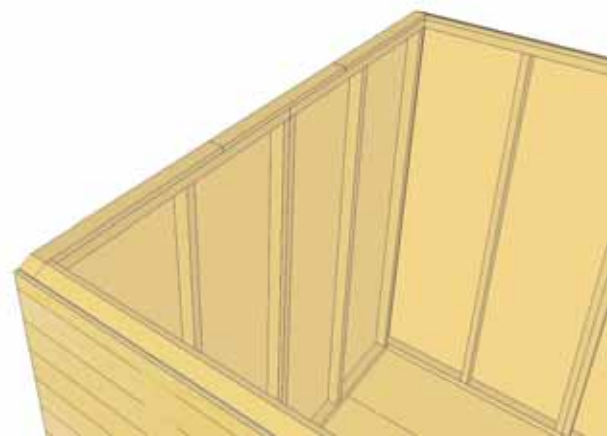
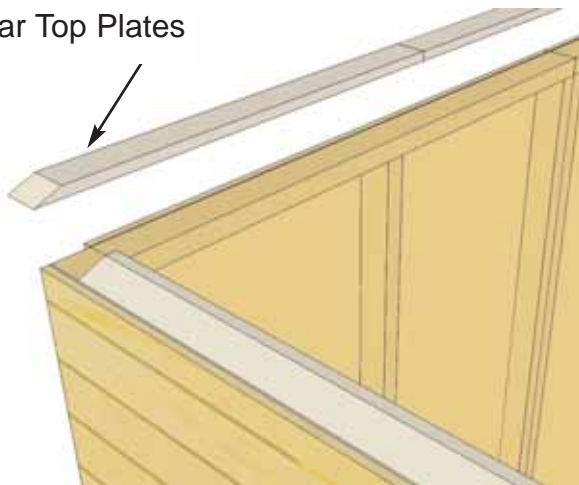

**27.** Position the Rear Top Plates on rear wall top framing to complete. Use 4 - 2" screws per piece.



**28.** Locate Gable 1/2 Walls for both front and rear of shed. Screw center wall framing of each piece together with 3 - 1 1/2" screws.

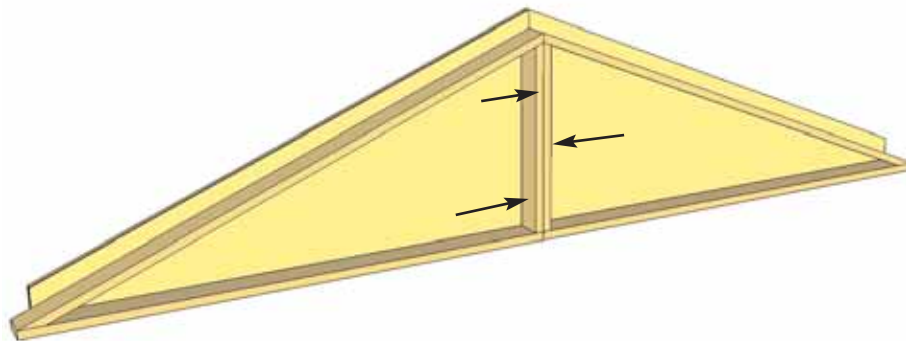

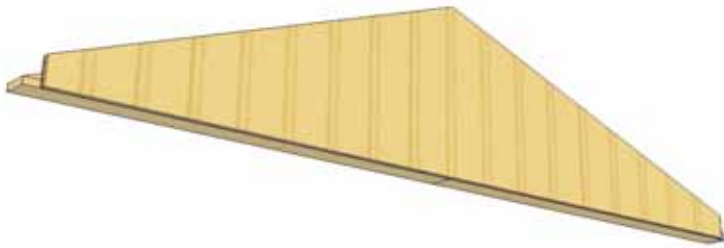

**Note-** Prior to attaching, check from front (siding side) to confirm siding lines up reasonably well. Try each combination prior to attaching together to get the best fit.

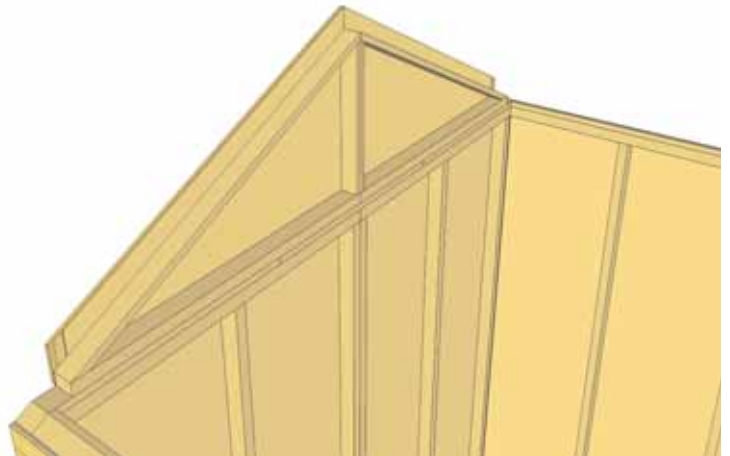
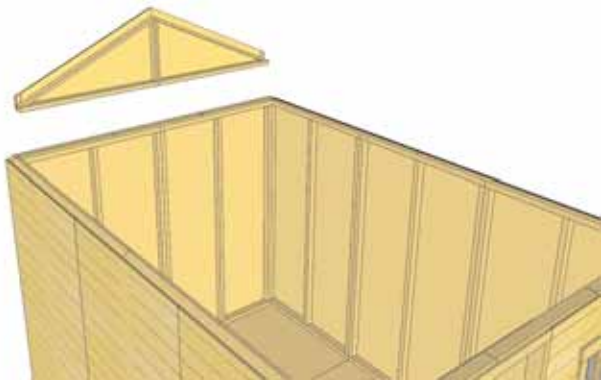

**29.** Lift up a completed gable section and place on top of Rear Top Plate on wall. The rear gable framing should sit flush with the inside of the top plate.

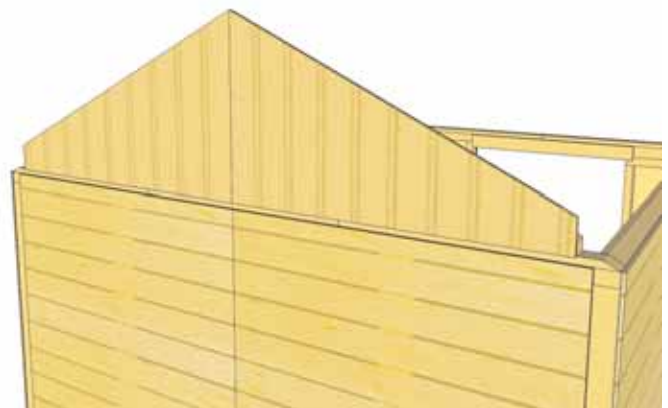
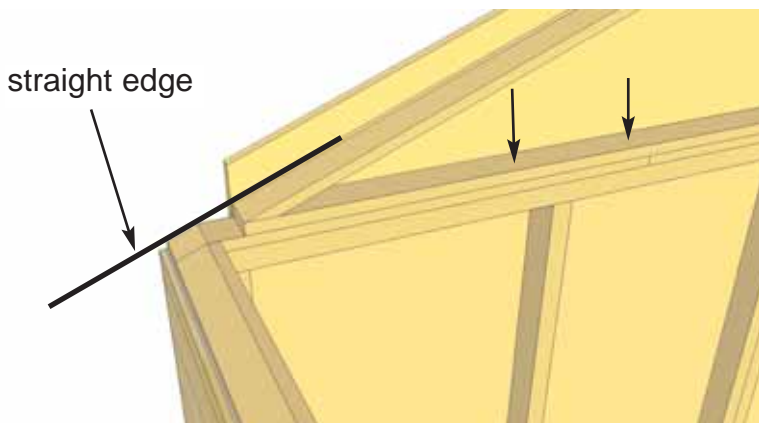

**30.** The gable should be centered sideways (left to right) on the top plate. **Hint:** use a straight edge to check the angle of the gable framing and top plate. Both angles should line up. Adjust gable accordingly. When positioned correctly, attach to walls and top plate with 8 - 2" screws. Screw from the bottom of gable framing down into Top Plate and Wall.

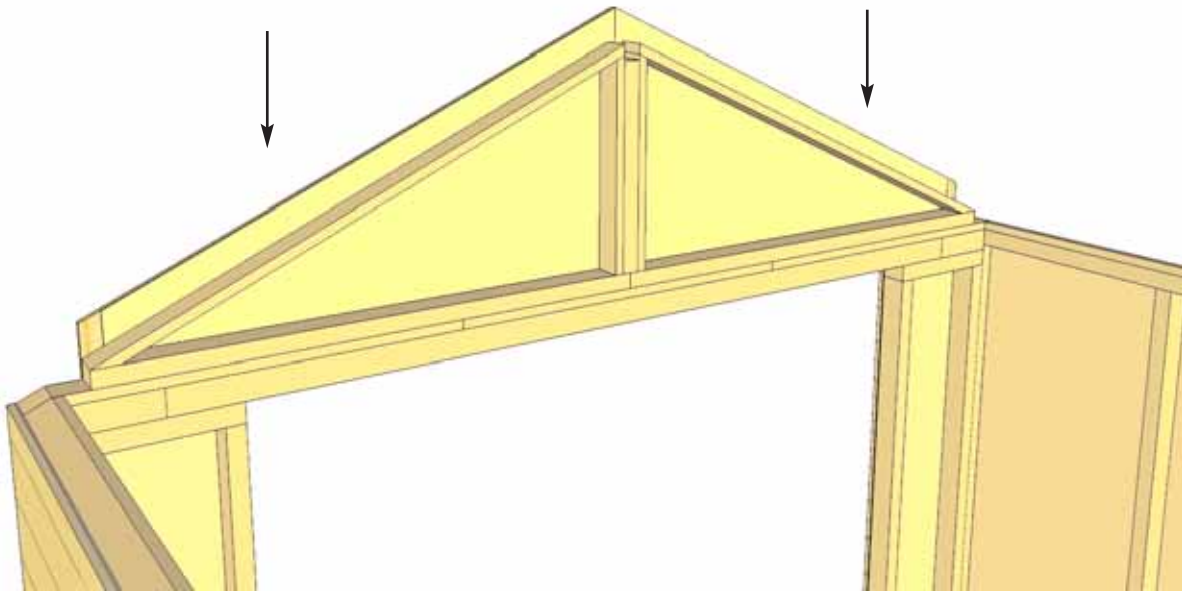

**31.** Complete positioning and attachment of front gable as per **Step 30.**

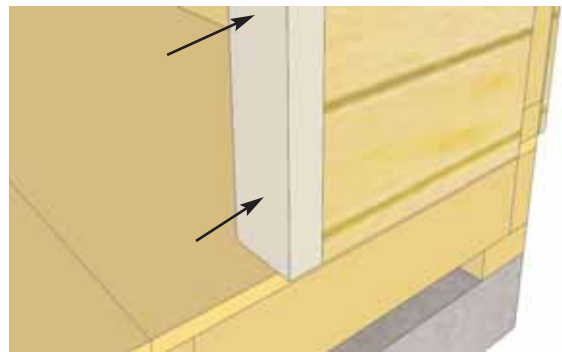

**31a.** Locate both Vertical Door Jambs and position flush against front narrow wall stud. The Jamb is 3" wide and will sit flush to outside of wall siding. When positioned correctly, secure Jamb using 4 - 2 1/2" screws. Complete both sides.



# C & D. Rafter and Roof Section

Exploded view of all parts necessary to complete the Roof Section. Identify all parts prior to starting. (Roof Filler Shingles Missing)

Note, Front wall configuration slightly different- disregard

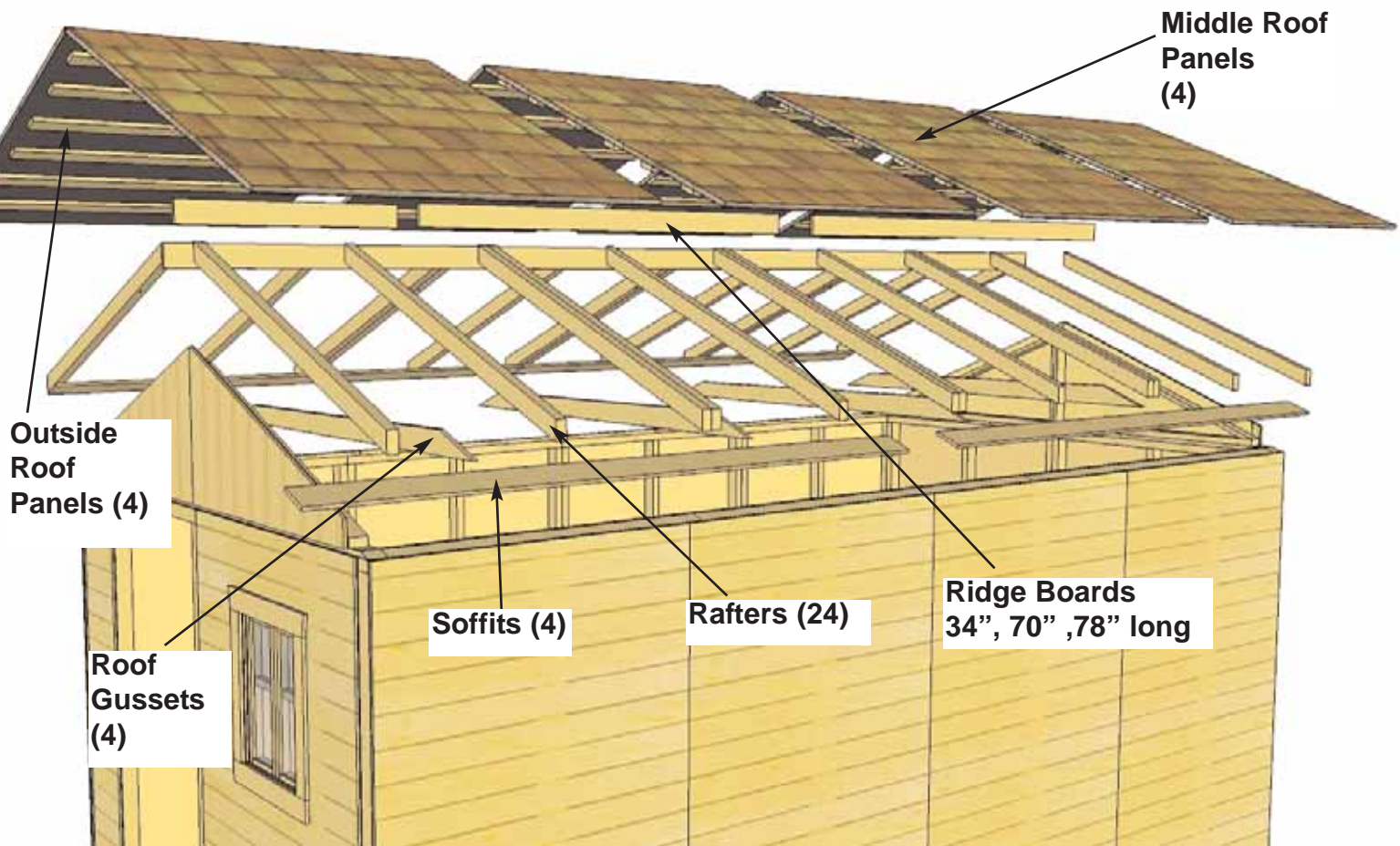

Ridge Board Connector

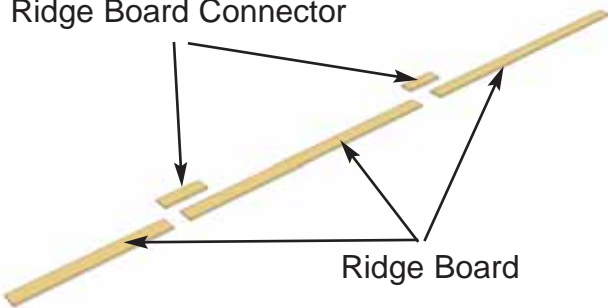

Ridge Board

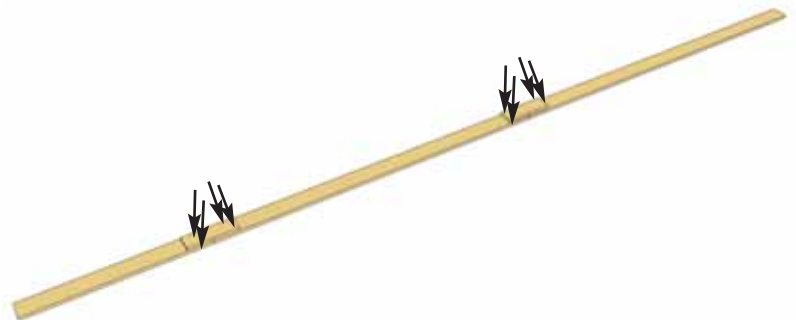

**32.** Locate 3/4" x 3 1/2" x 34", 70" & 78" Ridge Boards and attach together with Ridge Board Connectors using 4 - 1 1/4" screws per connection. Completed Ridge Board length = 182" long.

**33.** Locate 12 Rafters, 2 Soffits and completed Ridge Board. Lay out on level ground as shown to the right. Note, completed rafter section will be flipped over in **Step 37**.

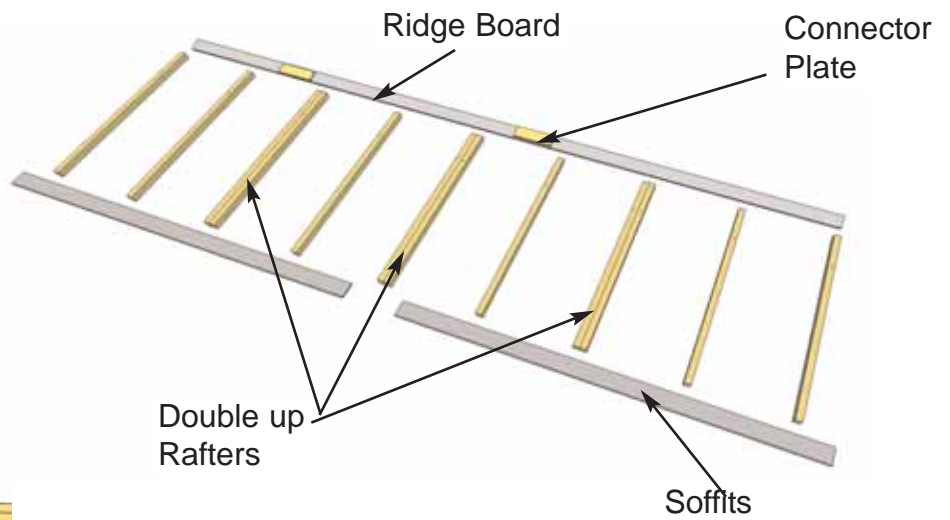

**34.** Attach completed Ridge Board to ends of both outside rafters with 2 - 1 1/4" screws per end. Measure and position interior Rafters as illustrated below. When positioned correctly, attach Ridge Board to remaining rafters with 2 - 1 1/4" screws /rafter end.

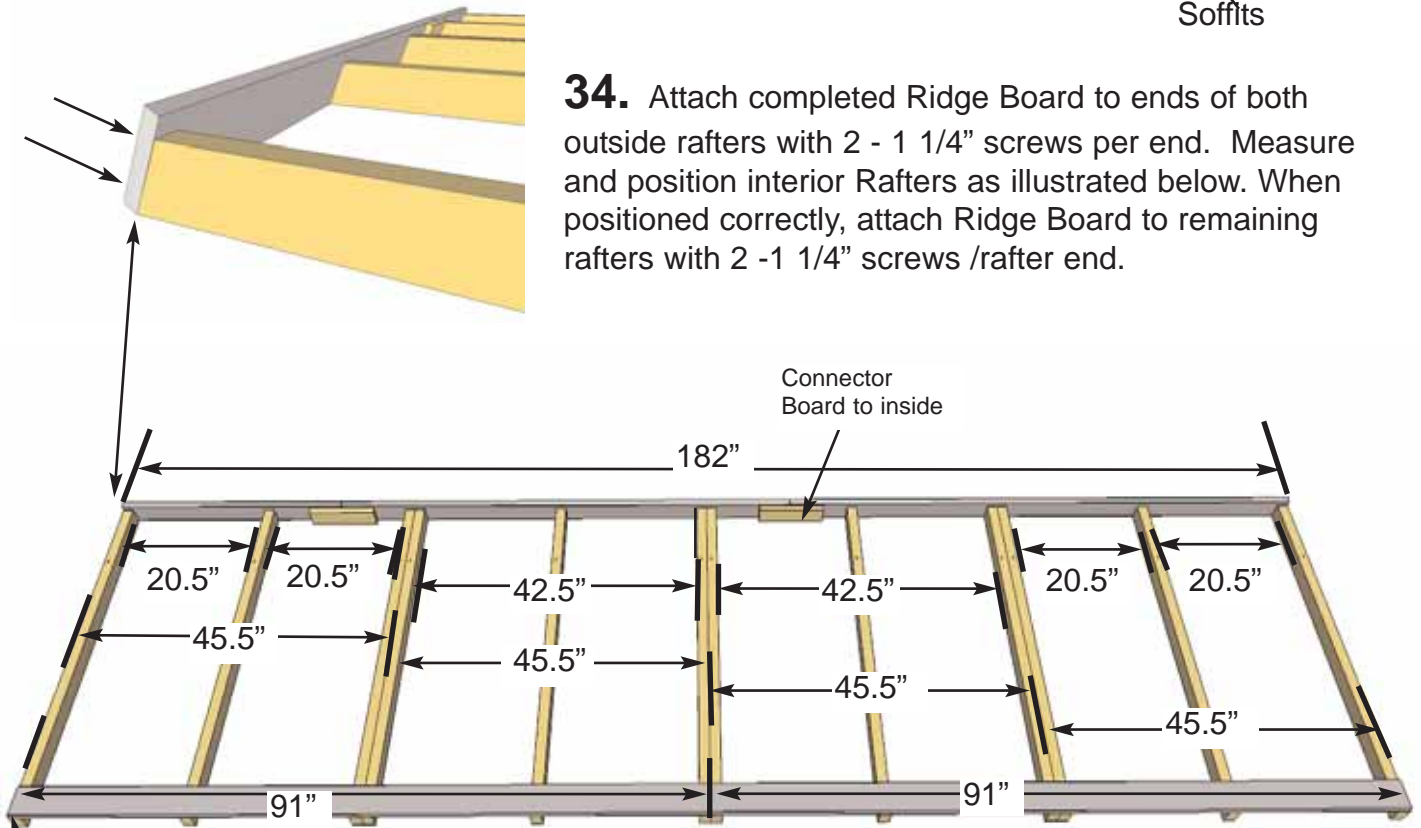

**35.** Attach end of a 91" long Soffit Board flush to ends of outside rafters with 2 - 1 1/4" screws per rafter end. Drill pilot hole in Soffit ends to prevent splitting. Complete both outside rafter / Soffit connections first. Measure and position interior Rafters as illustrated above. When positioned correctly, attach Soffits to remaining rafters with 2 - 1 1/4" screws /rafter.

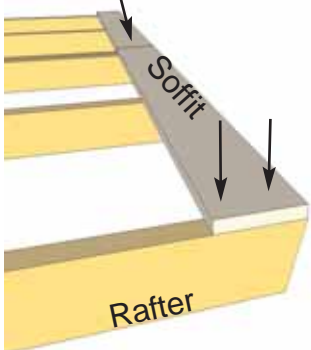

Flip completed rafter section over. Complete 2nd Rafter section now as per **Steps 32 - 34** with the following exception.

**When attaching Ridge Board to Rafter ends, make sure Ridge Board Connector is positioned so offset to first Rafter Section. See Step 44 for illustration.**

**36.** To fortify the completed Rafter Section prior to lifting on to roof, temporarily secure 2 - 75" long Filler Trim Pieces to rafters as shown to the left with 4 - 1 1/4" screws per pieces. **Important-** Do not discard Filler Trim Pieces, will need later.

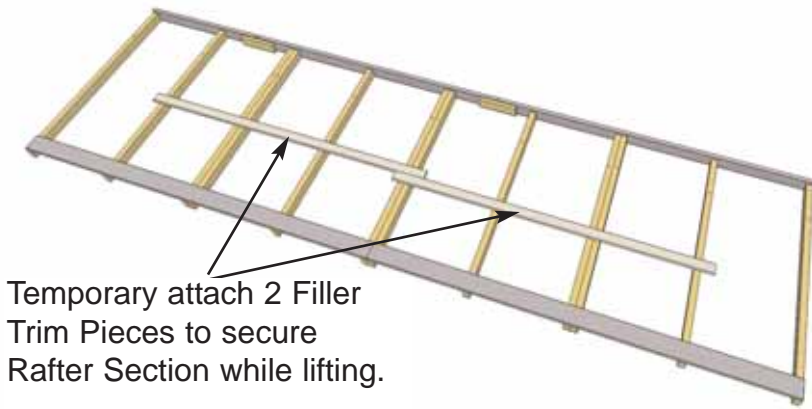

Temporary attach 2 Filler Trim Pieces to secure Rafter Section while lifting.

**37.** Flip Rafter Section over so Soffit is facing down.

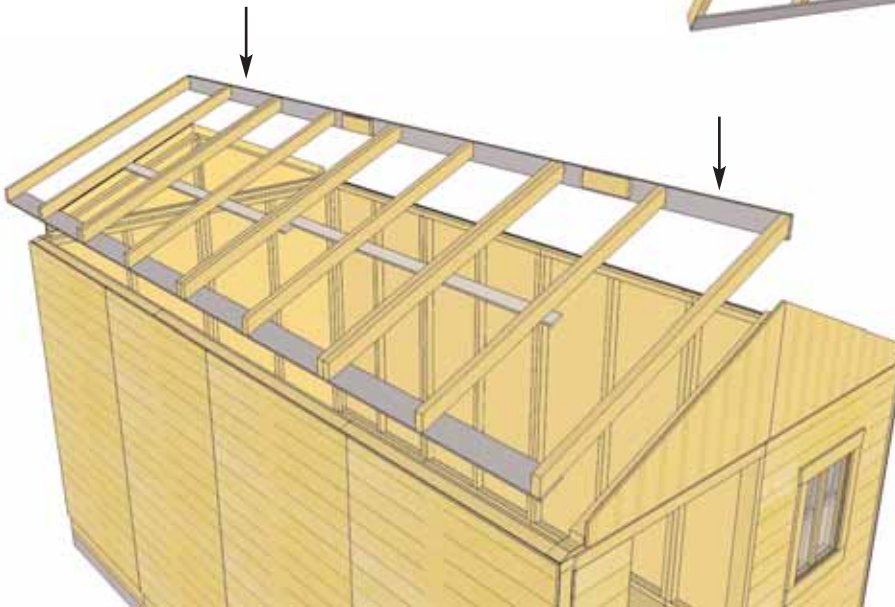

**38.** With several helpers, lift completed Rafter Section up above the walls.

**39.** Carefully slide outside rafters of Rafter Section up on gable framing.

Gable Framing

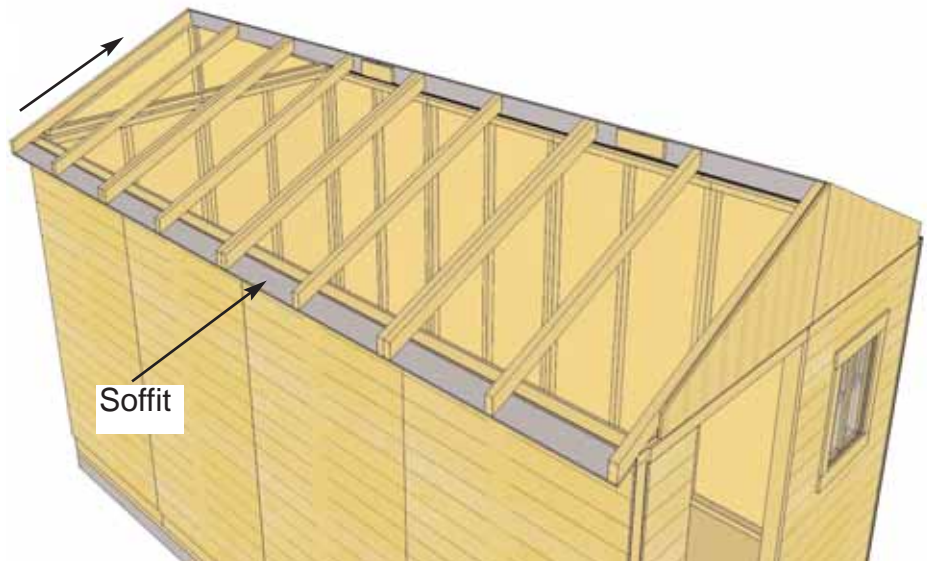

Soffit

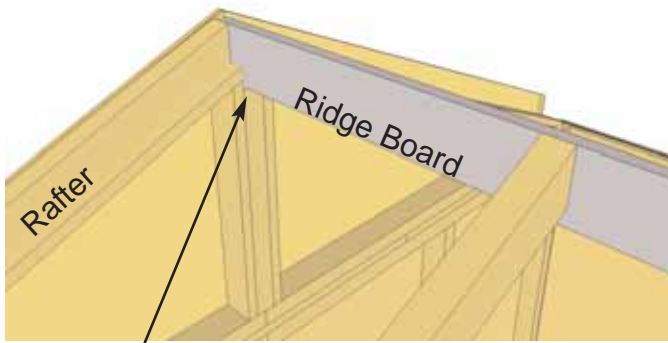

Gable Notch

**40.** Slide Rafter Section up on gable framing until bottom of Ridge Board slips into gable notch.

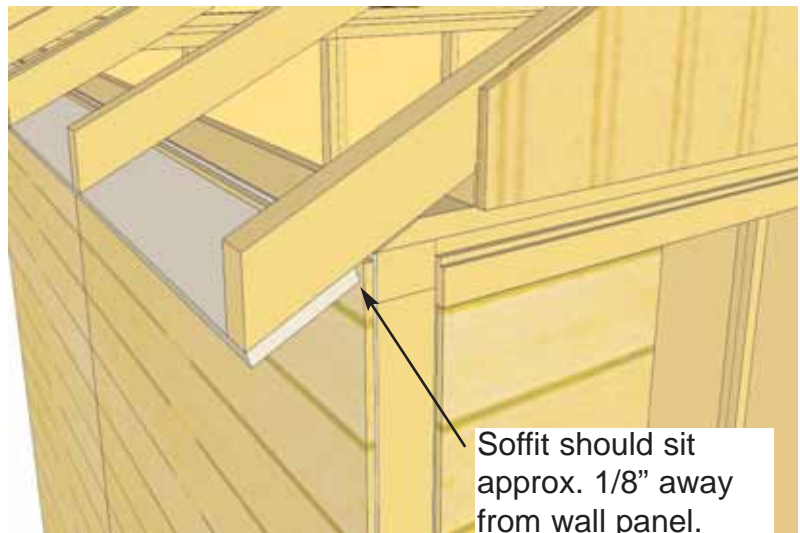

Soffit should sit approx. 1/8" away from wall panel.

Rafter should rest on gable framing

Soffit should sit against wall panel.

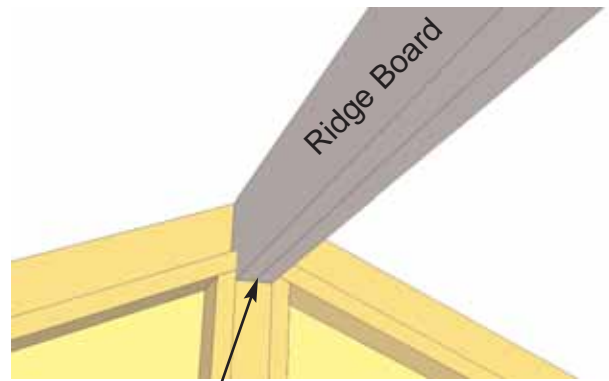
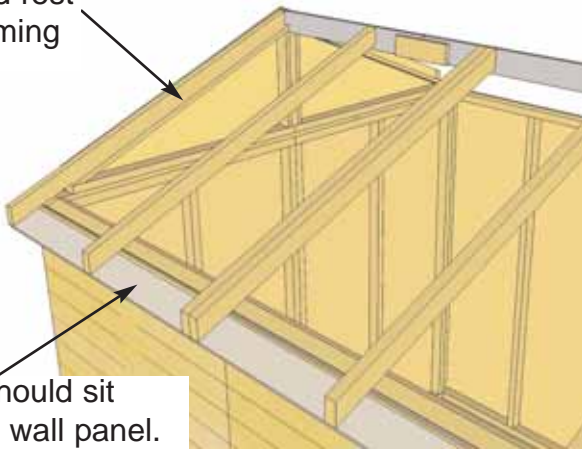

Gable Notch

**42.** Slide 2nd completed Rafter Section on gable wall framing. Position as per **Steps 40 & 41.**

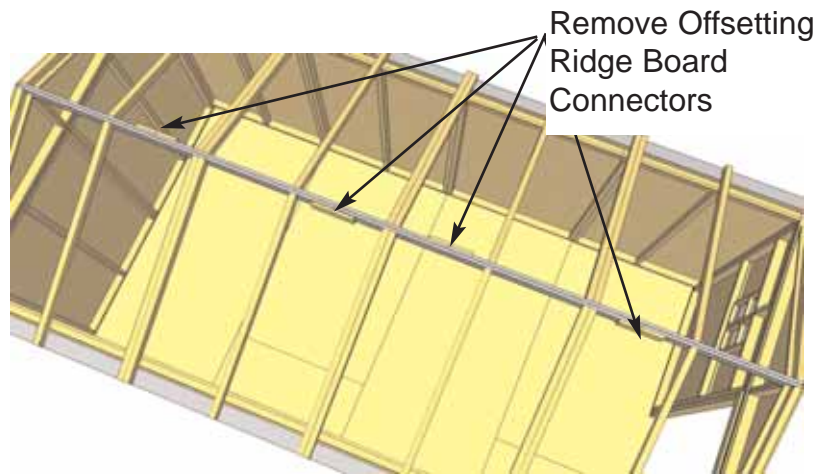

**43.** Remove temporary Filler Trims required to help support Rafter Sections.

**Important-** Do not discard, will need later.

Remove Offsetting Ridge Board Connectors from Ridge Boards.

**41.** When Rafter Section is positioned correctly on gable framing on both sides, tack in place to hold position with 1 - 2" screws.

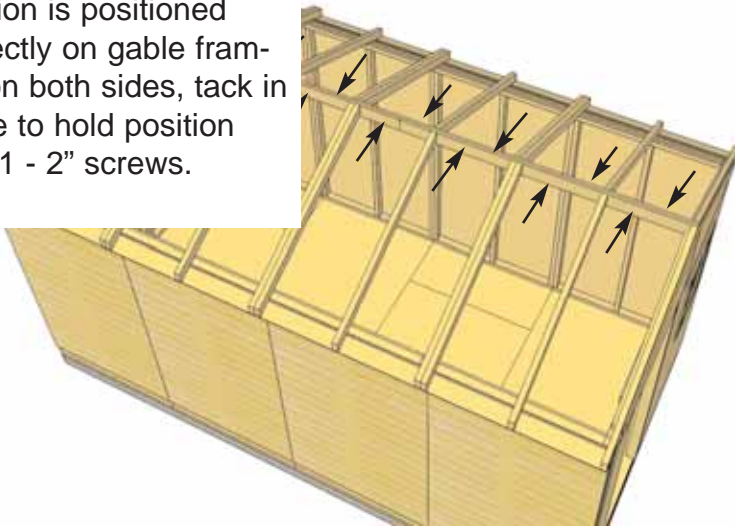

**44.** At the peak, align Ridge Boards so they are flush together and secure them with 16 - 1 1/4" screws. **Important-** if there is a gap between Ridge Boards, try pushing side walls closer together from outside. Walls should be 91" apart at top from inside of wall plate to wall plate.

**45.** With both Rafter Ridge Boards connected. Completely secure Gable framing to both outside rafters with 8 - 2" screws per gable side.

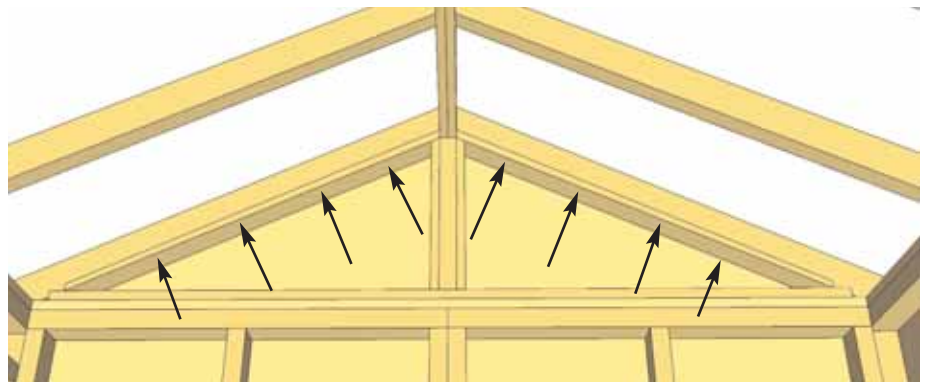

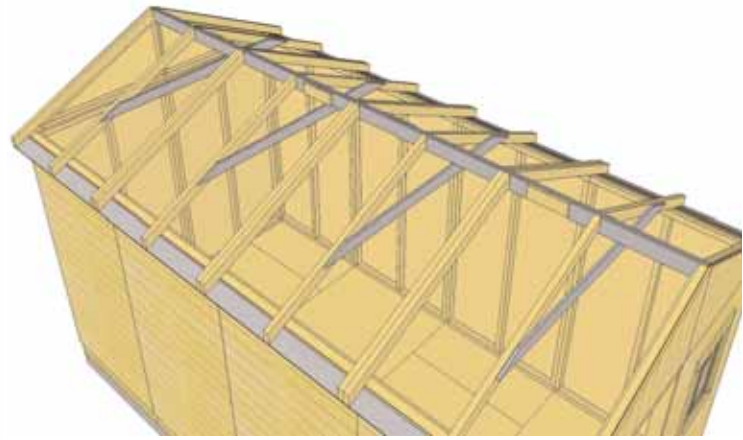
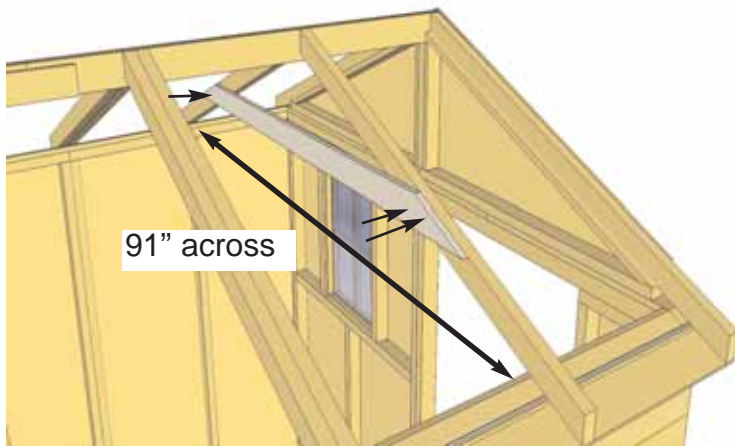

**46. Roof Gussets** are positioned on middle rafters. Prior to attaching, make sure front and rear walls are properly aligned. Have two helpers push the front and rear walls at the top from the outside of shed until inside to inside measurement between front and rear plates is 91". When correct, slide gusset up, use level to square gusset and attach to rafters with 4 - 1 1/2" screws. Complete remaining Gusset.

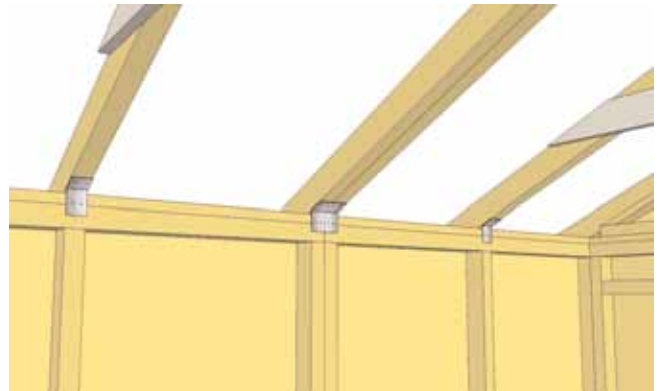
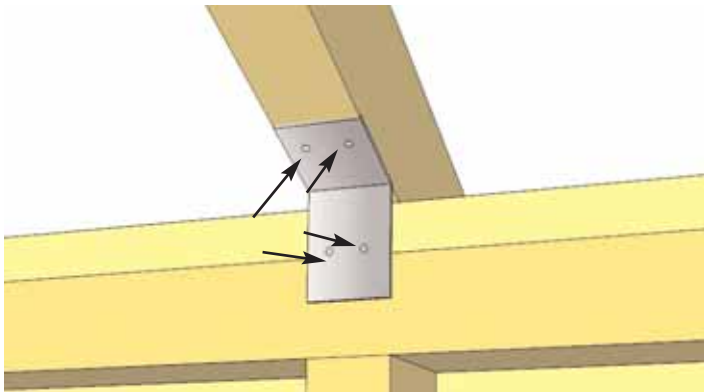

**47.** Attach **Simpson Strong Ties** to Top Wall framing and plates and also to the underside of the rafters. Use 4 - 1 1/4" screws to secure. There are 4 Ties per side.

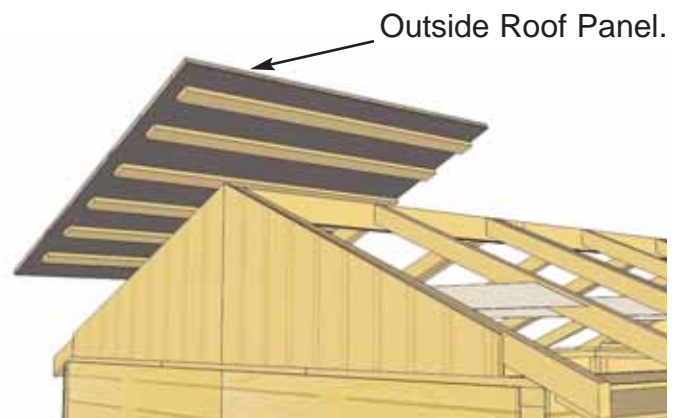
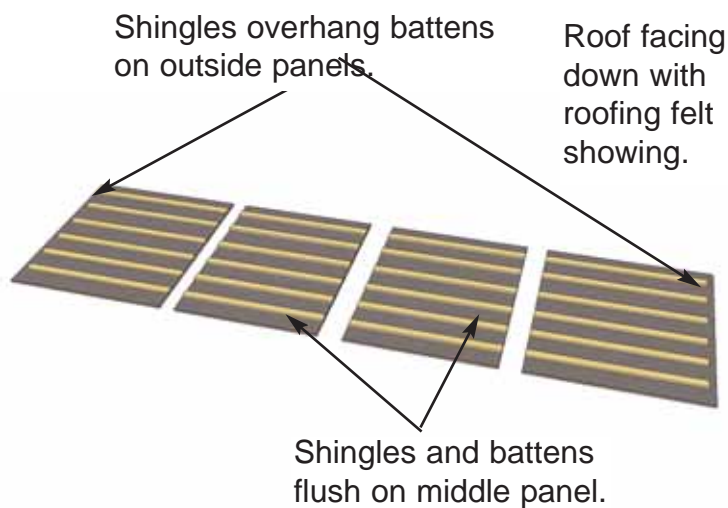

**48.** Identify Roof Panels. There are 4 Outside and 4 Mid Roof Panels. Starting with Rear Outside Roof Panel, lift up and place on rafters.

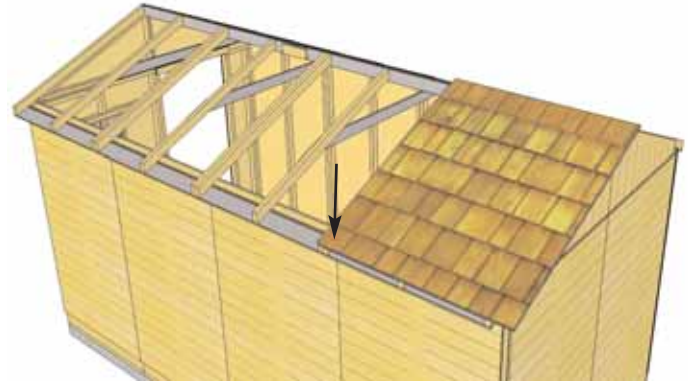
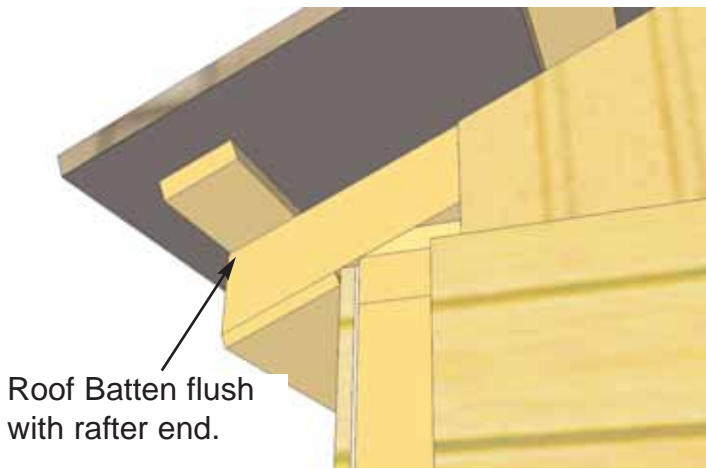

**49.** Place Roof Panel so it sits flush on 3rd rafter from the outside (doubled up rafter). Lowest batten on roof should be flush with end of rafter at bottom. From the outside, screw down through bottom row of shingles into rafter with 1 - 2 1/2" screw.

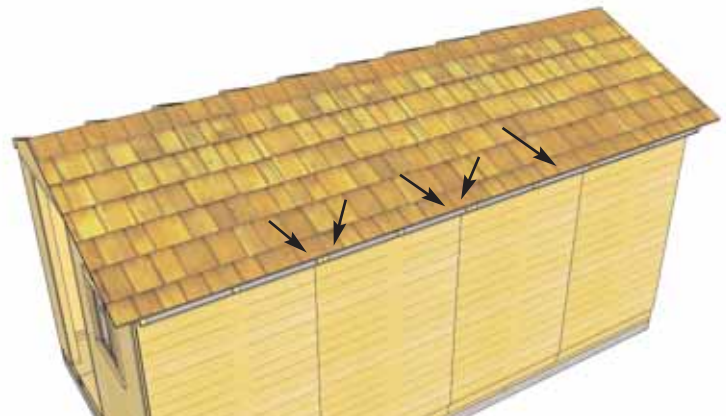
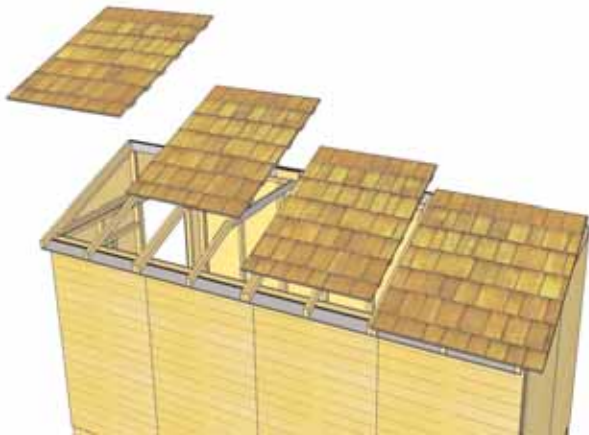

**50.** Locate 2 Mid Roof Panels (roof battens flush to with shingles) and Front Outside Roof Panel (shingles overhang battens). Place on rafters and align panels as per **Step 49**. Screw Mid Panels down to rafters with 2 - 2 1/2" screws in the bottom row of shingles. Attach Front as per **Step 49**.

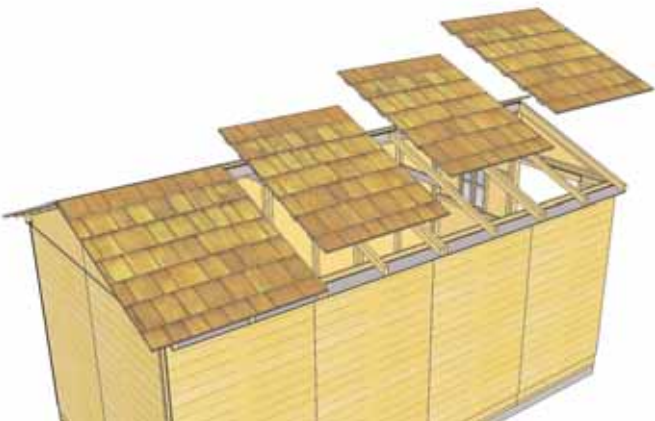

**51.** Position and attach remaining Roof Panels as per **Steps 49-50**.



**52.** Roof **Filler Shingles** are included to cover roof seams. Starting at the bottom, slide the first 24" long shingle in until flush with other bottom shingles. **DO NOT ATTACH UNTIL STEP 53.**



Attach above the exposure line.  
Exposure Line

**53.** Screw first filler shingle down to rafters using 1 - 2.5" screw per panel. Make sure to screw into rafter.



**54.** Slide in another filler shingle and attach as per **Step 53**. On your last row of shingles, the filler shingle is precut to fit properly. Attach to roof with 2 finishing nails per shingle.

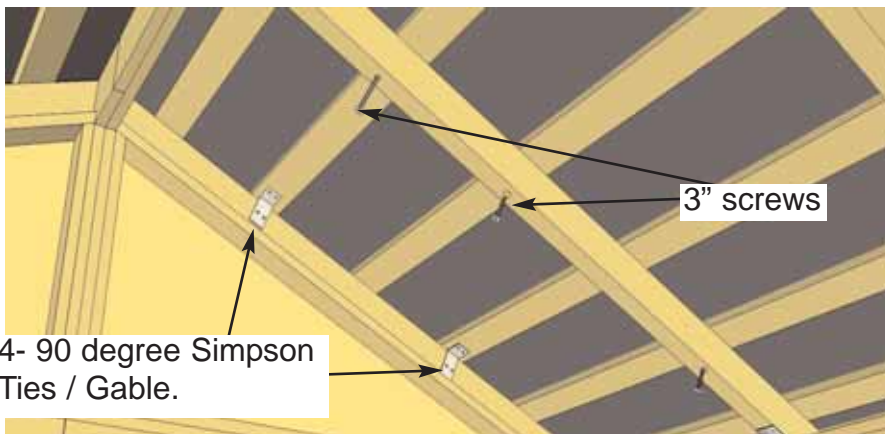

4- 90 degree Simpson Ties / Gable.

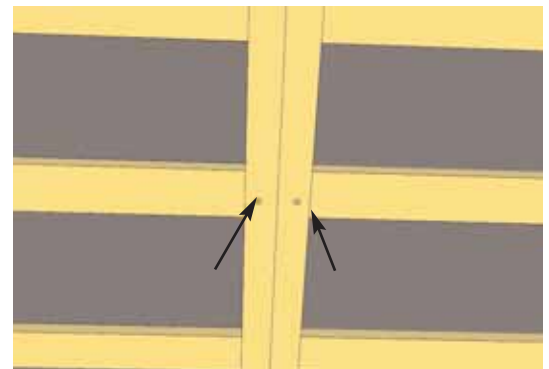

**55.** To further secure roof panels, from the inside, locate pre-drilled holes in Mid Rafters (3 per Rafter). Using 2 - 3" screws, secure rafters to roof battens. **Note**, from outside, push roof panel down so batten sit flush against rafter when securing. Also position 2 Simpson Strong ties on battens and outside rafters and secure 4 - 1 1/4" screws. 8 ties in total.

# E. Miscellaneous Section

Exploded view of all parts necessary to complete the Miscellaneous Section. Identify all parts prior to starting.

**Note:** Illustrations shows 8x12 Shed. Slightly different for 8x15 shed.

## E. Misc. Section

Exploded view of all parts necessary to complete the Miscellaneous Section. Identify all parts prior to starting.

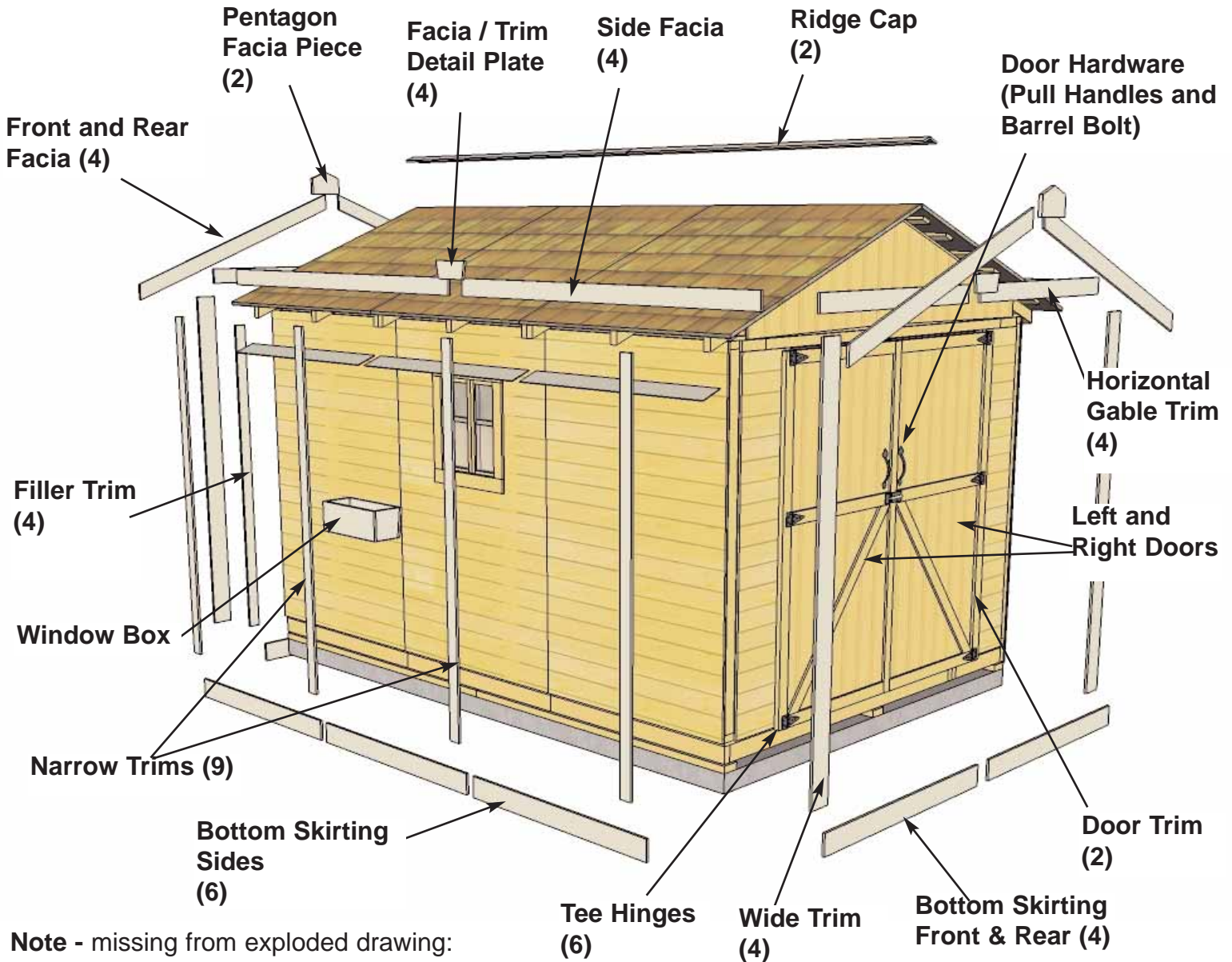

**Note** - missing from exploded drawing:  
Interior Door Stops and Interior Cane Bolt.

Note, picture shows 8x12 Model - 1 additional skirting per side for 8x15

### 56. Attach **Bottom Skirting**

around the base of the shed. Skirting will hide floor framing. The front & rear skirting pieces will meet together in the center. Gaps on outside will be covered by Wide Trim pieces later. Start with side skirting and attach with 3 - 1 1/2" screws per piece. Use 4 screws on both front skirting pieces for extra support since it will be a high traffic area.

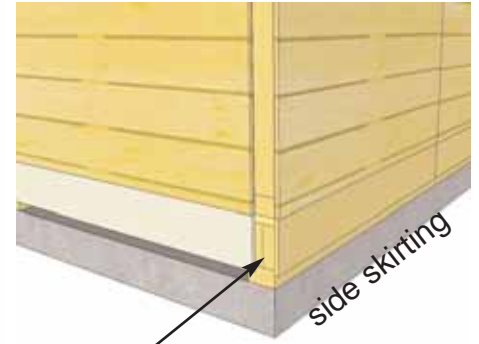

Gap in corner

side skirting

4 pieces of Bottom Skirting for sides / 2 pieces for front and rear.

### 57. Attach **Corner Trim**

**Filler Strips** (4 - 1/2" x 2 1/2" x 75") to front and rear walls in each corner. Hammer with 6 - 1 1/2" finishing nails. Strips are positioned flush with siding and bottom skirting.

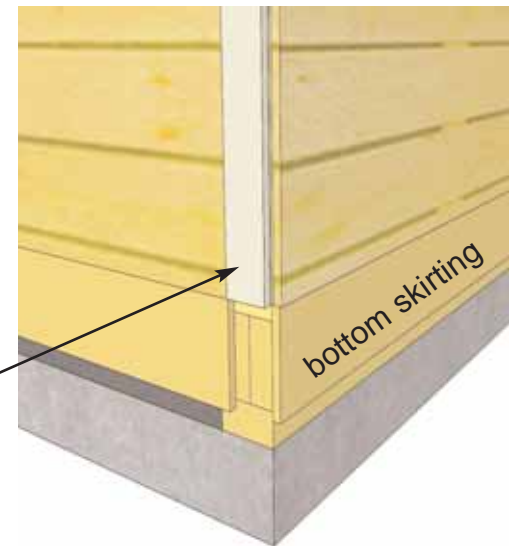

bottom skirting

Note, pictures shows 8x12 Model - same for 8x15

### 58. Attach **Side Wide Corner Trim**

(4 - 1/2" x 4 1/2" x 79") over filler trim. Use 6 - 1 1/2" finishing nails per piece. Once again, trim should be flush at bottom of bottom skirting. Trim should also overhang sidewall siding by 1/2".



rear of shed

1/2" overhang



Bottom Skirting

Wide Corner Trim



Note, picture shows 8x12- same for 8x15

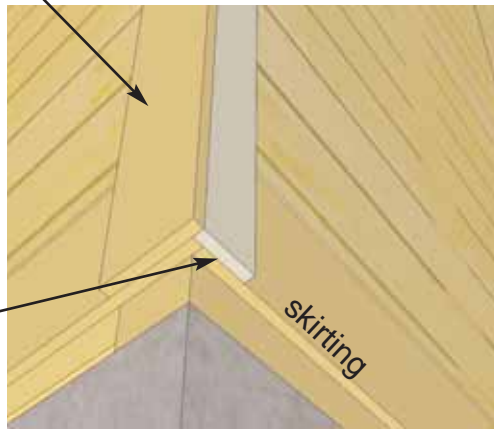

**59.** Attach **Narrow Corner Trims** to in each corner (4 - 1/2" x 2 1/2" x 79" long). Use 6 - 1 1/2" finishing nails per piece. Align Trim so flush with bottom of bottom skirting and flush with Wide Corner Trim.

Note, picture shows 8x12- 4 Narrow Trim / Side for 8x15

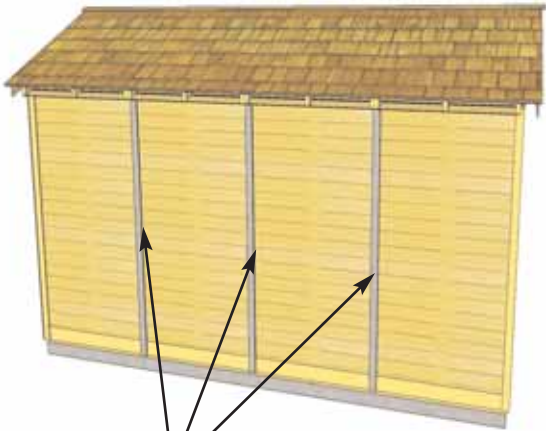

Narrow Wall Trim

**60.** Attach **Narrow Wall Trim** (10 - 1/2" x 2 1/2" x 79") where wall panels come together and leave a seam. Position trim equally on each wall and use 6 - 1 1/2" finishing nails per piece. Align Trim so flush at bottom of bottom skirting. Attach **Rear Wall Narrow Trim** - 77 1/2" long to rear wall seam.



Narrow Wall Trim

Note, picture shows 8x12- 4 Side Facia/Side for 8x15

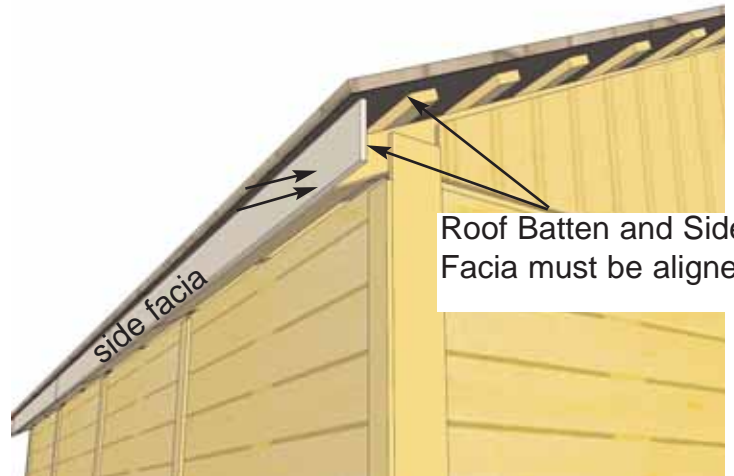

Roof Batten and Side Facia must be aligned.

**61.** Attach **Side Facia** to roof rafter ends. There are 4 facia pieces per side. Secure with 8 - 1 1/2" finishing nails per piece. Front and Rear Facia will overhang Side Facia therefore facia should be positioned where roof battens end. Do a dry run with End Facia to confirm correct positioning.



**62.** Attach **End Facia** (angle cut on ends) to front and rear of shed to end of roof battens. Line facia up to form a peak and attach to battens with 3 - 1 1/2" screws per piece. End of facia should be aligned flush with end of rafter. Where Side and End Facia meet, attach together with 2 finishing nails.

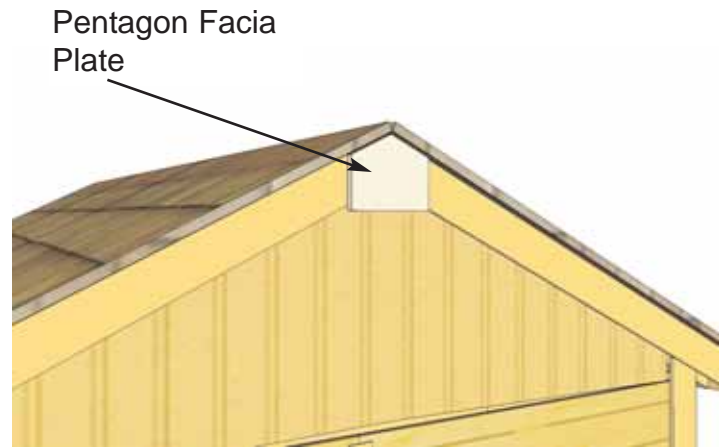

**63.** Attach **Pentagon Facia Plate** where End Facia meets at the peak. Use 4 - 1 1/2" finishing nails per piece to secure.

Note, picture shows 8x12 Model- same for 8x15

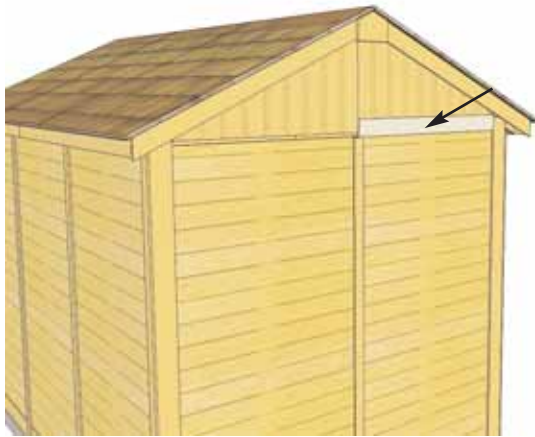

**64.** Attach **Horizontal Gable Trim** ( 4- 1/2" x 3 1/2" x 44") to rear of shed. Position equally over gable and wall seam. Use 4 - 1 1/2" finishing nails per piece to secure. (2 pieces per side).



**65.** Complete front Horizontal Gable Trim as per **Step 64.**

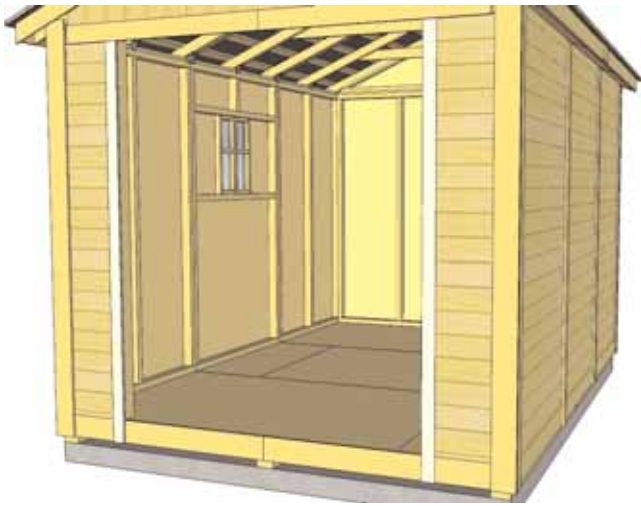

**66.** Position **Door Trim** (2 - 1/2" x 2 1/2" x 77 1/2") pieces flush with outside of door jamb and flush with bottom of bottom skirting. Attach with 6 - 1 1/2" finishing nails.

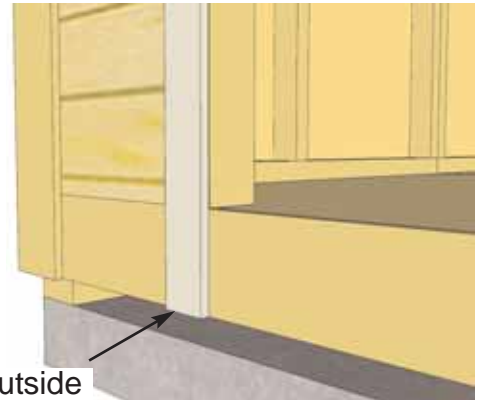

Flush with outside of door jamb and bottom skirting.



**67.** Attach **Facia/Trim Detail Plates** to cover seam where fascia and horizontal trim pieces come together. Secure each with 4 - 1 1/2" finishing nails

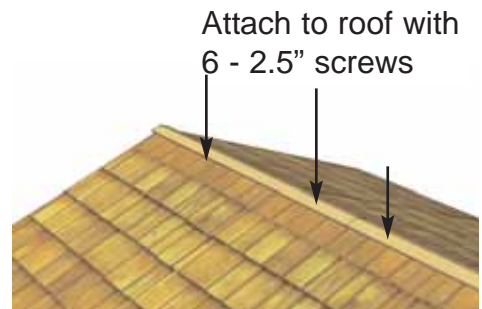
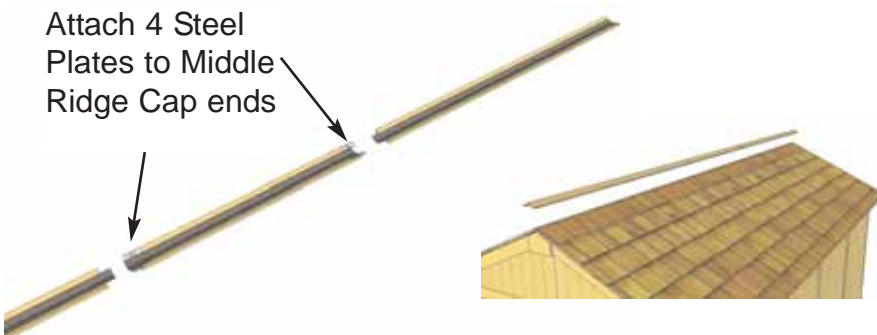

**68.** Attach 3 pieces of Ridge Caps together using steel plates found on Middle Ridge Piece. Use 3/4" screws to secure. Carefully lift up complete Ridge Cap and lift on top of the roof peak. Attach to roof with 6 - 2.5" screws. **Note:** Ridge caps will overhang the roof shingles equally on both ends.

Attach Black Tee Hinges with 3/4" Black hardware provided

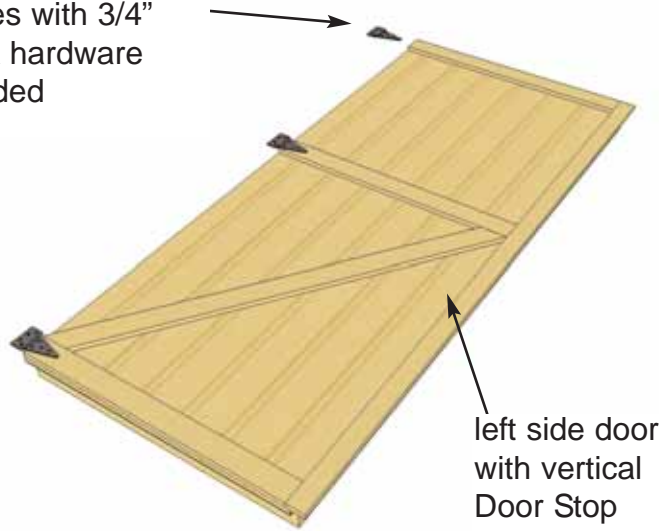

**Note**, illustration of Hinge may not be accurate. The # of screw holes in the hinge may vary from three to four depending on model.

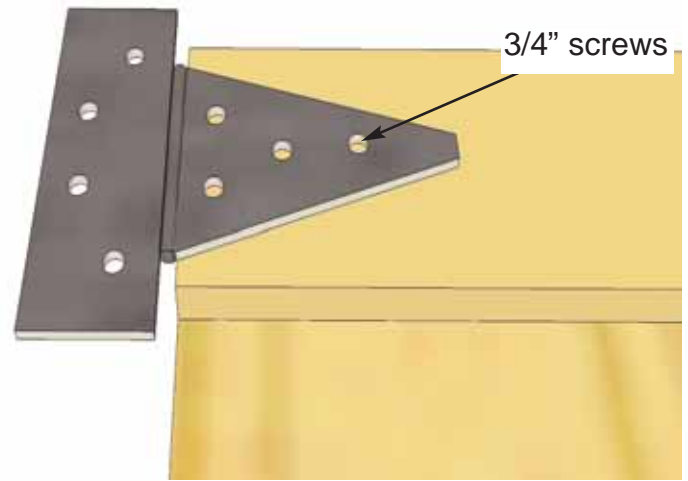

**69.** Attach Door Hinges to both **left** and **Right Side Double Doors**. Position Hinges equally on door trim as shown above and attach with Black 3/4" screws included in each hinge package. Note, Left Side Door has an additional vertical door stop located on the right (inside of door when shut).

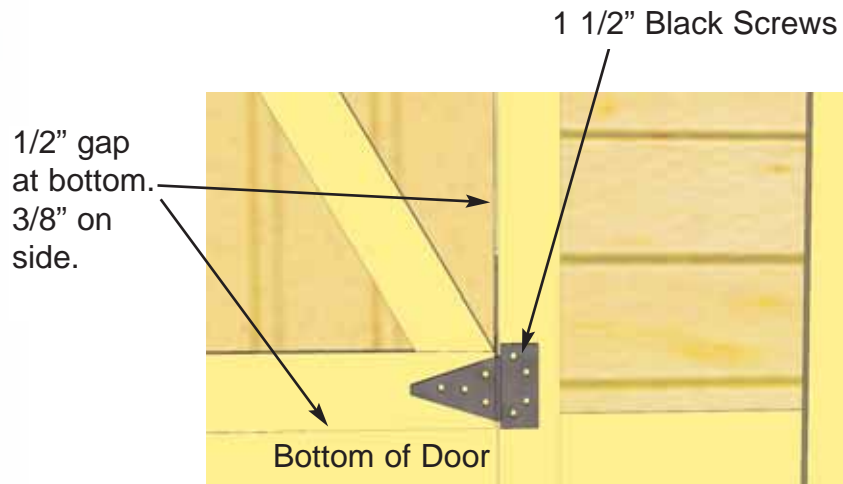

**70.** Next, position and secure the Double Doors. Starting with **Right Side Door**, position so there is a 1/2" gap on bottom and approximately 3/8" on the side. Use a piece of **Interior Door Stop** (used later) to shim door in place at the bottom. Note, door trim will overhang the floor from the outside. Using 1 1/2" black screws, secure hinges to Door Trim. Hint: Do not attach all the 1 1/2" screws until both doors are positioned correctly into place. Use Screw Driver to tighten screws completely.



**71.** Position **Left Side Door** as per **Step 70** and secure with 1 1/2" Black Screws. When satisfied with door positioning, complete all 1 1/2" screws. Note, Do not over tighten hinge screws when using screw gun. Tighten 3/4 and use a Screw Driver finish so as not to strip screws.





**72.** Attach **Door Handles, Exterior Barrel Bolt** and **Interior Cane Bolt** to doors. Handles are positioned on top section of each door. Male Barrel Bolt piece will be positioned on left door trim. Interior Cane Bolt will be attached to bottom of right door framing from the inside. To position Cane Bolt correctly, attach to door framing first, close doors and mark hole to house can bolt rod. Open doors and drill hole where previously marked. Use hardware provided in each kit to complete installation of all hardware.



**73.** Attach Horizontal and Vertical **Door Stops** to door header and jambs. Start with horizontal Stop first and then complete both vertical stops. Position so door gap is covered. Use 4 - 2" screws per piece to secure.

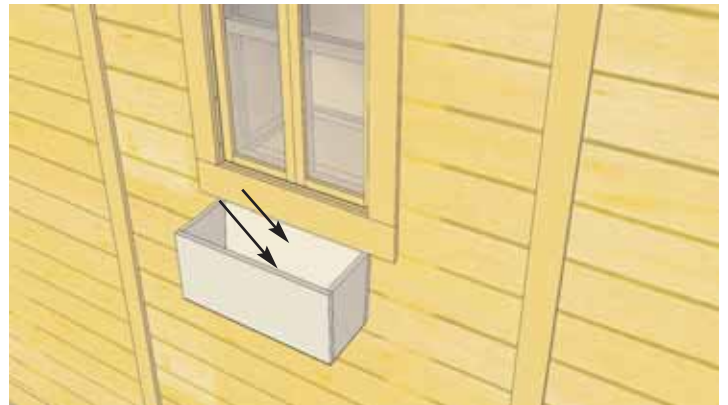

**74.** Attach **Window Box** below bottom of window trim with 2 - 2" screws per box. Screw from inside of box into the center wall stud. Attach second screw 2" below top screw.

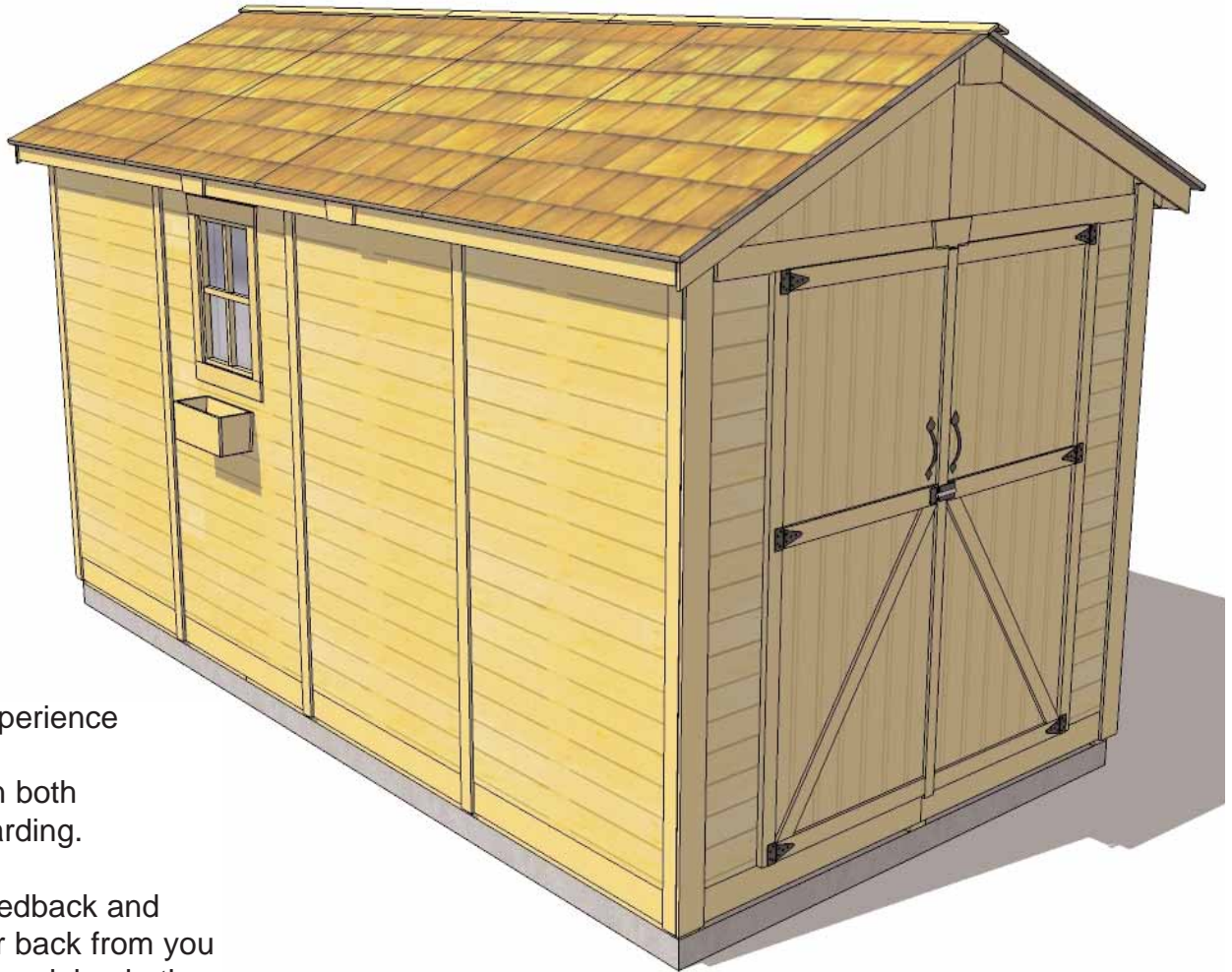

We hope your experience constructing our building has been both positive and rewarding.

We value your feedback and would like to hear back from you on how well we are doing in the following areas:

1. **Customer Service**
2. **On Time Shipping**
3. **Motor Freight Delivery**
4. **Quality of Materials**
5. **Assembly Manual**
6. **Overall Satisfaction.**

Please call, write or email us at:

**Outdoor Living Today Partnership**  
**P.O. Box 96**  
**Sumas, Washington**  
**98295**



The materials contained in this Assembly Manual may be downloaded or copied provided that ALL copies retain the copyright and any other proprietary notices contained on the materials. No material may be modified, edited or taken out of context such that its use creates a false or misleading statement or impression as to the positions, statements or actions.